

20 11

PRODUCT CATALOG

ROTORS SPRAYS MP ROTATOR VALVES CONTROLLERS CENTRAL CONTROL SENSORS DRIP/MICRO



Hunter[®]
THE IRRIGATION INNOVATORS

Catalog Owner

Sales Manager

Mobile

E-mail

Note

WHAT YOU HOLD IN YOUR HANDS IS THE LATEST INNOVATION IN THE IRRIGATION INDUSTRY.

This catalog of professional irrigation products is designed to make the information you are looking for easy to find. We simplified navigation with clear tabs for each section and a bar at the top of each page highlighting the main features of that product. We redesigned the spec builders and product charts to make them easier to read and understand.

This is not just a printed catalog; it is a companion to the hunterindustries.com website. Each product now has an easy-to-remember URL included on the page (i.e. www.hunterindustries.com/ICORE) where you can find more information, images, and technical specs. This allowed us to keep the catalog clear and easy to use while still providing a tremendous amount of product information.

"THIS CATALOG, ALONG WITH OUR PRODUCT INNOVATIONS, STARTED WITH FEEDBACK FROM YOU, OUR CUSTOMER."

Of course, there are many new products featured, all of which are highlighted on the facing page. We have new products to help simplify design and installation; irrigate more efficiently; reduce waste; and conserve water.

This catalog, along with all of our product innovations, started with feedback from you, our customer. Please keep the feedback coming, and we will continue to live up to our reputation as The Irrigation Innovators.



Greg Hunter,
Vice President of Marketing
Hunter Industries, Inc.



Greg Hunter,
Vice President of Marketing

Hunter[®]

WHAT'S NEW

TAKING GREAT DESIGN OFF THE PAGE AND INTO THE FIELD

An I-40 rotor runs in the field of Qualcomm Stadium in San Diego, California.



16 ROTORS

PGP ULTRA

Now with full-circle adjustment, non-strippable drive mechanism with auto-arc return, and other new features.



28 ROTORS

I-90 NOZZLES

Expanding the available selection from six to eight nozzles, the enhanced I-90 now offers both shorter and longer radius capabilities.



36 SPRAYS

PRO-SPRAY® FAMILY

Now expanded to three choices, find the spray that's right for the site.



53 VALVES

ACCU-SYNC™

A simple pressure regulator designed for all of Hunter's control valves. Both adjustable and fixed models available.



66 CONTROLLERS

X-CORE

A simple controller now with Solar Sync and Hunter remote compatibility.

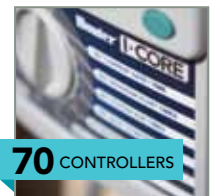

70 CONTROLLERS

I-CORE

Get modularity, an intuitive interface, and six language options in this commercial controller.

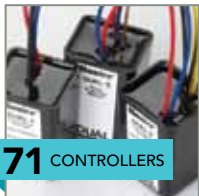

71 CONTROLLERS

DUAL

Two-wire systems require less labor, less maintenance, and less equipment cost.



74 CONTROLLERS

ICD-HP

The indispensable field tool for the decoder professional, saving installation and diagnostic time.



80 CENTRAL

IMMS 3.0

The central control system is now available with graphical user interface with customizable map-based navigation.



86 SENSORS

WIRELESS RAIN-CLIK

New frequency allows for global use and overall construction improved to prevent water intrusion.

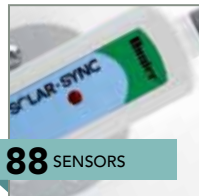

88 SENSORS

WIRELESS SOLAR-SYNC

The simple, compact ET sensor is now available in a wireless version, for easier and faster installation.



92 DRIP/MICRO

PLD: TEE AND AIR RELIEF

Applies water slowly and evenly for consistent distribution so water soaks in gradually, easily reaching its intended goal.

BLUE PRINT OF AN EFFICIENT IRRIGATION SYSTEM

A properly designed, managed, and maintained irrigation system is an essential tool for a healthy, functional landscape. The Hunter products featured here will maximize the effectiveness of the water you use.

PGP Ultra and I-20



Hunter rotors are the best choice when watering a large turf or landscape area. Our nozzles are engineered for excellent water distribution at low precipitation rates to keep landscape looking its best, while using water efficiently.

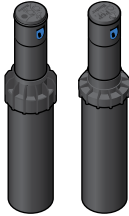

Pro-Spray and Nozzles



Smaller areas require spray sprinklers for proper watering. Hunter's spray bodies are available with pressure regulation to ensure the most accurate watering of any landscape. Hunter's spray nozzles are meticulously engineered and tested to provide even watering and efficient use.

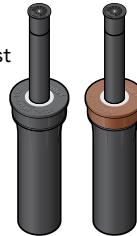

MP Rotator



The ultimate solution for small-to medium-sized areas, this high-efficiency, low precipitation rate sprinkler offers unmatched performance and proven water savings up to 30% over sprays.



PGV, ICV and Drip Control Kits



Hunter's trusted valve line ensures system reliability and accuracy. Accu-Sync can be used on systems with excess pressure to extend the life of the system components and provide the correct operating pressure to the sprinklers. Drip zone kits are equipped with pressure regulators and filters to provide drip and micro irrigation components with the correct pressure and contaminant-free water.

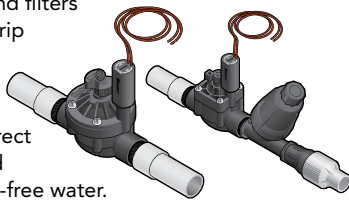

Drip/Micro Irrigation



Drip irrigation is an efficient choice for certain landscape situations. It applies water directly to the root zone area of landscape plants, helping to limit excess irrigation. Micro spray emitters can be used to cover small planting beds efficiently.

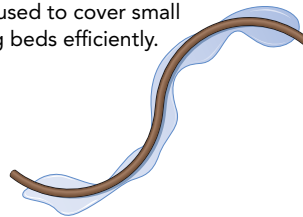

Pro-C/I-Core



The correct controller for the job is essential to meet the needs of any landscape, from unpredictable weather to municipal watering requirements. Having a customizable controller that is sensor compatible is the first step to a water-efficient system.

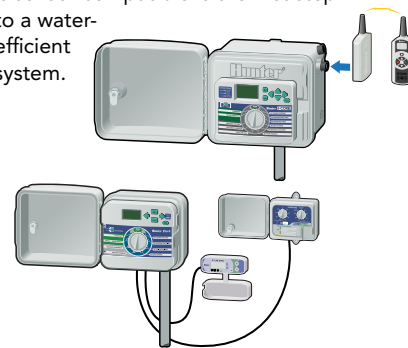

Flow-Clik/HFS



Flow sensors prevent systems from running when there is a leak or broken component. The Flow-Clik will work with most Hunter controllers to suspend irrigation, and the HFS is compatible with specific Hunter controllers to monitor overflow and provide flow totaling for better management.

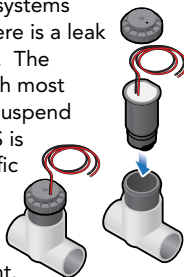

Solar Sync



Solar Sync monitors weather, working with the controller to adjust the system for changing conditions, ensuring water is not wasted.

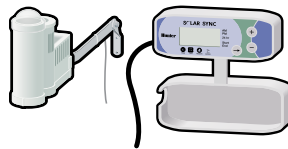

LEGEND

- SPRAY HEADS
- ROTORS
- MP ROTATORS
- CONTROL VALVES
- LANDSCAPE DRIPLINE
- WEATHER SENSOR
- FLOW SENSOR
- CONTROLLER



TABLE OF CONTENTS

ROTORS

SPRAYS/NOZZLES

MP ROTATOR

VALVES

CONTROLLERS

Advanced Features ... 10	Advanced Features ... 32	MP Rotator..... 48	Advanced Features ... 52	Advanced Features ... 64
PGJ 12	PS Ultra..... 34		ACCU-SYNC™ 53	X-Core 66
SRM..... 13	Pro-Spray® 36		SRV..... 54	PCC..... 67
PGP 14	PRS30 37		PGV 55	Pro-C..... 68
PGP Ultra..... 16	PRS40 38		PGV Jar-Top 56	ICC..... 69
I-20 18	Pro Adjustable Nozzles 40		PGV-ASV 57	I-Core..... 70
I-25 20	Pro-Spray® Fixed Arc Nozzles 42		ICV 58	Dual..... 71
I-35 22	Nozzles 44		IBV..... 59	ACC 72
I-40 24	Nozzles/Bubblers 45		Quick Couplers..... 60	ACC-99D 73
I-60 26				HFS 74
I-90 28				ICD-HP..... 74
				ROAM..... 75
				ICR 75
				SVC 76
				WVS 76
				XC Hybrid..... 77



CENTRAL

SENSORS

DRIP/MICRO

ACCESSORIES

TECHNICAL

IMMS 3.0 80	Mini-Clik® 84	PLD 92	Accessories 98	Replacement Guide ... 100
	Freeze-Clik® 84	Micro Irrigation 93		Precipitation Rates .. 104
	Wind-Clik® 85	Drip Zone		Slope Equivalents/ Irrigation 105
	Mini Weather Station 85	Control Kits 94		Height of Spray 106
	Rain-Clik™ 86	Design Illustration 95		PLD Charts 108
	Flow-Clik™ 87	Root Zone		Drip Zone Control Kit Charts 109
	Pump Start Relay 87	Watering System 96		Conversion Factors . 110
	Solar Sync 88			Pressure Loss Chart 111
	ET System 89			Friction Loss Charts 112
				Wire Data 119
				Wire Sizing 120
				Additional Data 121

See page 126 for Statement of Warranty.

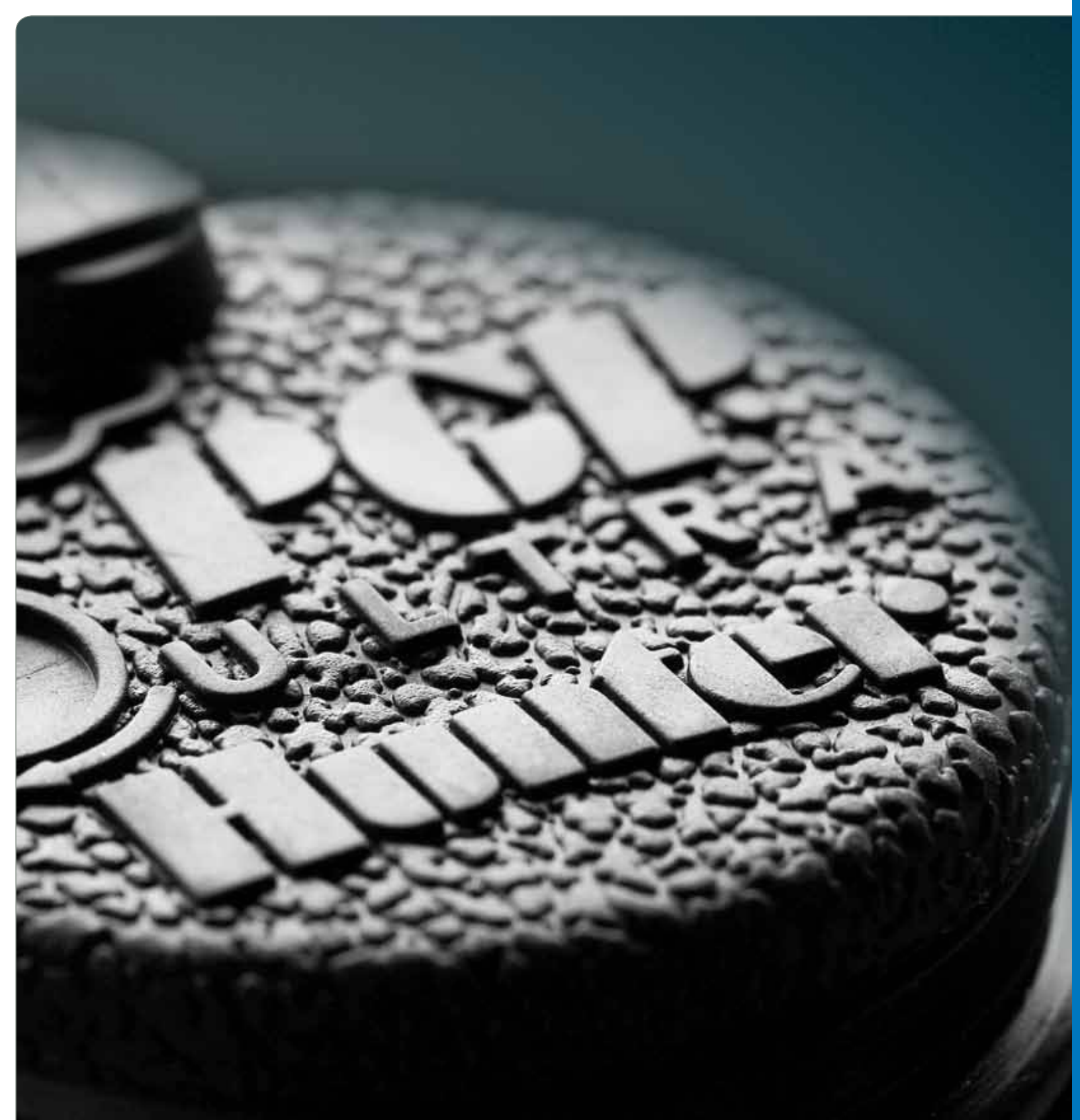

TALK ABOUT A REVOLUTION. When Edwin Hunter invented the rotor that would become the blockbuster PGP in the mid-1980s, the industry would be forever changed. Now with a fully expanded portfolio to meet any challenge, **Hunter rotors are the embodiment of a decades-old legacy married with forward-thinking innovation.**

ROTORS

COMPARISON CHART

	PGJ	SRM	PGP	PGP ULTRA	I-20	I-25	I-35	I-40	I-60	I-90
APPLICATIONS										
Spacings 15' to 37'	•	•		•	•					
Spacings 25' to 45'			•	•	•					
Spacings more than 45'						•	•	•	•	•
Residential	•	•	•	•	•					
Commercial/institutional				•	•	•	•	•	•	•
Athletic fields					•	•	•	•		•
High vandalism areas				•	•	•	•	•		•
Low pressure systems	•	•	•	•					•	
Riser-mounted sprinklers	•			•	•					
Ground cover and/or shrubs	•		•	•	•					
Reclaimed water ID cover	•			•	•	•	•	•	•	•

ADVANCED FEATURES

AUTOMATIC ARC RETURN
 This feature returns to the original arc regardless of where the turret is turned. This ensures vandal protection in any environment.
 PGP Ultra, I-20, I-25, I-35, I-40

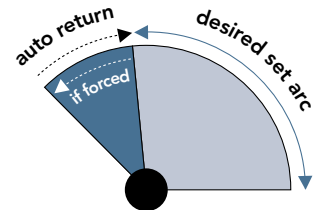

NON-STRIPPABLE DRIVE
 The patent-pending, non-strippable, vandal proof drive mechanism enables the turret to be turned without causing damage.
 PGP Ultra, I-20, I-25, I-35, I-40



PART- AND FULL-CIRCLE IN ONE MODEL
 Patented non-reversing 360 for part- and full-circle in one model, from 50 to 360 degrees.
 PGP Ultra, I-20, I-25, I-35, I-40

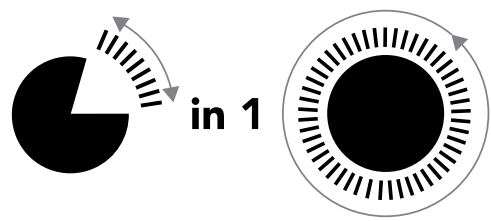

HEADED AND SLOTTED SET SCREW
 Use a slotted screwdriver or the Hunter wrench for easier and simpler adjustments as needed.
 PGJ, PGP Ultra, I-20, I-35



FLOSTOP™ CONTROL
 FloStop closes the flow of water from individual sprinkler heads while the system is running. This is ideal for changing nozzles or turning off specific heads during maintenance and construction.
 I-20, I-35



OPPOSING NOZZLE 360° MODEL

The opposing nozzle design offers excellent water distribution. With primary and secondary nozzles on opposing sides of the turret, streams arc in opposite directions as the sprinkler rotates for outstanding midrange and close-in watering.

I-40, I-90



COLOR CODED NOZZLES

Nozzles are easier to differentiate in the field for simple installation and quick organization.

I-25, I-35, I-60, I-90



STAINLESS STEEL RISER

For unforgiving soil conditions, unpredictable climates, or heavy foot traffic, stainless steel is the best choice.

Standard on I-40 and I-60; optional on I-20, I-25, and I-35



RECLAIMED WATER ID

Purple caps indicate where non-potable irrigation water is being used.

PGJ, PGP Ultra, I-20, I-25, I-35, I-40, I-60, I-90



DRAIN CHECK VALVE

As air in lines can cause long-term damage to rotors and plumbing, the drain check valve keeps lines from draining when the system is shut off. This saves water, reduces liability, and increases system life.

PGJ, PGP Ultra, I-20, I-25, I-35, I-40, I-60, I-90



PGJ

APPLICATION

Residential

RADIUS

15' to 37'

FLOW RATE

0.64 to 5.3 GPM

THE PGJ HAS ALL THE BENEFITS OF A ROTOR IN A COMPACT, SPRAY-SIZED PACKAGE.

FEATURES

- Models: Shrub, 4", 6", 12"
- Arc setting: 40 to 360 degrees
- Nozzle choices: 8
- Nozzle range: 0.75 to 5.0
- Standard factory installed nozzle: 2.0 only
- Factory installed rubber cover
- Through-the-top arc adjustment
- Quick check arc mechanism
- Water lubricated gear-drive
- Warranty period: 2 years

ADVANCED FEATURES

- Headed and slotted set screw
- Reclaimed water ID (optional)
- Drain check valve (optional)
- = Detailed descriptions on pages 10 and 11

OPERATING SPECIFICATIONS

Radius: 15' to 37'
 Flow rate: 0.64 to 5.3 GPM
 Recommended pressure range: 30 to 50 PSI
 Operating pressure range: 20 to 100 PSI
 Precipitation rates: 0.6 in/hr approx.
 Nozzle trajectory: 14 degrees approx.

FACTORY INSTALLED OPTIONS

Drain check valve (up to 7' of elevation)
 Reclaimed water ID cover

USER INSTALLED OPTIONS

Drain check valve (up to 7' of elevation; P/N 462078)

PGJ Nozzle Performance Data

Nozzle	Pressure PSI	Radius ft.	Flow GPM	Precip in/hr	
				■	▲
.75	30	15	0.64	0.55	0.63
	40	16	0.75	0.56	0.65
	50	17	0.85	0.57	0.65
1.0	30	18	0.85	0.51	0.58
	40	19	1.0	0.53	0.62
	50	19	1.1	0.59	0.68
1.5	30	21	1.3	0.57	0.66
	40	22	1.5	0.60	0.69
	50	22	1.7	0.68	0.78
2.0	30	24	1.7	0.57	0.66
	40	25	2.0	0.62	0.71
	50	25	2.3	0.71	0.82
2.5	30	27	2.2	0.58	0.67
	40	28	2.5	0.61	0.71
	50	28	2.8	0.69	0.79
3.0	30	30	2.5	0.53	0.62
	40	31	3.0	0.60	0.69
	50	31	3.4	0.68	0.79
4.0	30	33	3.7	0.65	0.76
	40	34	4.0	0.67	0.77
	50	34	4.3	0.72	0.83
5.0	30	36	4.7	0.70	0.81
	40	37	5.0	0.70	0.81
	50	37	5.3	0.75	0.86

Note: All precipitation rates calculated for 180 degree operation. For the precipitation rate for a 360 degree sprinkler, divide by 2. Optimum nozzle performance shown in bold.

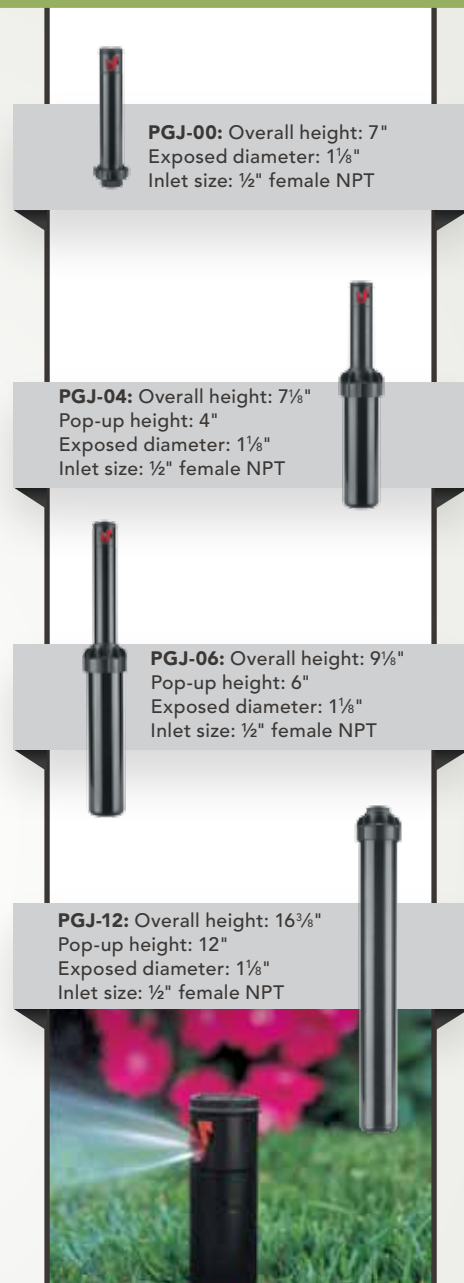

SPECIFICATIONBUILDER

www.hunterindustries.com/PGJ

MODELS	STANDARD FEATURES	FEATURE OPTIONS
PGJ-00 = Shrub	Adjustable arc, 8 standard nozzles	R
PGJ-04 = 4" pop-up		V, R
PGJ-06 = 6" pop-up		V, R
PGJ-12 = 12" pop-up		V, R

V = Drain check valve
 R = Drain check valve and reclaimed water ID

EXAMPLES

PGJ-04	4" pop-up, adjustable arc
PGJ-06 - V	6" pop-up, adjustable arc, with drain check valve
PGJ-12 - R	12" pop-up, adjustable arc, with drain check valve and reclaimed water ID

SRM

APPLICATION

Residential

RADIUS

15' to 30'

FLOW RATE

0.42 to 3.4 GPM

THIS SHORT RANGE ROTOR OFFERS LOW PRECIPITATION RATES FOR APPLICATIONS THAT NORMALLY CALL FOR SPRAYS.

FEATURES

- Model: 4"
- Arc setting: 40 to 360 degrees
- Nozzle choices: 6
- Nozzle range: 0.50 to 3.0
- Standard factory installed nozzle: 3.0 only
- Through-the-top arc adjustment
- Quick check arc mechanism
- Water lubricated gear-drive
- Warranty period: 2 years

OPERATING SPECIFICATIONS

Radius: 15' to 30'

Flow rate: 0.42 to 3.4 GPM

Recommended pressure range:
30 to 50 PSI

Operating pressure range: 20 to 100 PSI

Precipitation rates: 0.45 in/hr approx.

Nozzle trajectory: 18 degrees approx.

USER INSTALLED OPTIONS

Drain check valve (up to 7' of elevation; P/N 462078)

SRM Nozzle Performance Data

Nozzle	Pressure PSI	Radius ft.	Flow GPM	Precip in/hr	
				■	▲
.50	30	15	0.42	0.36	0.41
	40	16	0.50	0.38	0.43
	50	17	0.58	0.39	0.45
.75	30	17	0.64	0.43	0.49
	40	18	0.75	0.45	0.51
	50	19	0.85	0.51	0.58
1.0	30	19	0.85	0.45	0.52
	40	20	1.0	0.48	0.56
	50	20	1.1	0.53	0.61
1.5	30	23	1.3	0.47	0.55
	40	24	1.5	0.50	0.58
	50	25	1.7	0.52	0.60
2.0	30	25	1.7	0.52	0.60
	40	26	2.0	0.57	0.66
	50	27	2.3	0.61	0.70
3.0	30	28	2.5	0.61	0.71
	40	30	3.0	0.64	0.74
	50	30	3.4	0.73	0.84

Note: All precipitation rates calculated for 180 degree operation. For the precipitation rate for a 360 degree sprinkler, divide by 2. Optimum nozzle performance shown in bold.

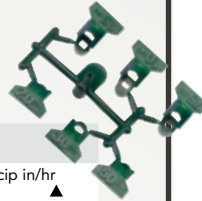

SRM-04: Overall height: 6 $\frac{3}{8}$ "
Pop-up height: 4"
Exposed diameter: 1 $\frac{1}{8}$ "
Inlet size: $\frac{1}{2}$ " female NPT

ROTORS

SPECIFICATIONBUILDER

www.hunterindustries.com/SRM

MODELS

STANDARD FEATURES

SRM-04 = 4" pop-up

Adjustable arc, 6 standard nozzles

EXAMPLE

SRM-04	4" pop-up, adjustable arc
---------------	---------------------------

PGP

APPLICATION

Residential

RADIUS

22' to 52'

FLOW RATE

0.5 to 14.1 GPM

AFTER THREE DECADES, THE WORLD'S BEST SELLING ROTOR IS STILL NUMBER ONE.

FEATURES

- Model: 4"
- Arc setting: 40 to 360 degrees
- Nozzle choices: 27 total
- Nozzle racks: #1 to #12 red, 1.5 to 8.0 blue, #4 LA to #10 LA gray
- Factory installed rubber cover
- Through-the-top arc adjustment
- Quick check arc mechanism
- Water lubricated gear-drive
- Warranty period: 2 years

ADVANCED FEATURES

- Low angle nozzle choices

OPERATING SPECIFICATIONS

Radius: 22' to 52'

Flow rate: 0.5 to 14.1 GPM

Recommended pressure range: 25 to 70 PSI

Operating pressure range: 20 to 100 PSI

Precipitation rates: 0.4 in/hr approx.

Nozzle trajectory: Std = 25 degrees, Low angle = 13 degrees

FACTORY INSTALLED OPTIONS

Nozzles: #5 to #8 red, 1.5 to 4.0 blue

USER INSTALLED OPTIONS

Drain check valve (up to 4' of elevation; P/N 142300)



PGP-ADJ: Overall height: 7 $\frac{3}{8}$ "
Pop-up height: 4"
Exposed diameter: 1 $\frac{3}{4}$ "
Inlet size: $\frac{3}{4}$ " female NPT



SPECIFICATIONBUILDER

www.hunterindustries.com/PGP

MODELS	STANDARD FEATURES	NOZZLE OPTIONS
PGP-ADJ-B = 4" pop-up	Adjustable arc, with BLUE nozzle rack	1.5 to 4.0 = Factory installed nozzle number
PGP-ADJ = 4" pop-up	Adjustable arc, with RED nozzle rack	#5 to #8 = Factory installed nozzle number
PGP-ATR = Impact replacement	Adjustable arc, with RED nozzle rack	#7 = Factory installed nozzle number

EXAMPLES

PGP-ADJ	4" pop-up, adjustable arc
PGP-ADJ-B - 3.0	4" pop-up, adjustable arc, and 3.0 BLUE nozzle
PGP-ADJ - 07	4" pop-up, adjustable arc, and #7 RED nozzle

PGP CHARTS



PGP Red Standard Nozzle
Performance Data (P/N 130900)

Nozzle	Pressure PSI	Radius ft.	Flow GPM	Precip in/hr	
				■	▲
1	30	28	0.5	0.12	0.14
	40	29	0.6	0.14	0.16
	50	29	0.7	0.16	0.19
	60	30	0.8	0.17	0.20
2	30	29	0.7	0.16	0.19
	40	30	0.8	0.17	0.20
	50	30	0.9	0.19	0.22
	60	31	1.0	0.20	0.23
3	30	30	0.9	0.19	0.22
	40	31	1.0	0.20	0.23
	50	31	1.2	0.24	0.28
	60	32	1.3	0.24	0.28
4	30	32	1.2	0.23	0.26
	40	33	1.4	0.25	0.29
	50	34	1.6	0.27	0.31
	60	34	1.8	0.30	0.35
5	30	34	1.6	0.27	0.31
	40	36	1.8	0.27	0.31
	50	38	2.0	0.27	0.31
	60	38	2.2	0.29	0.34
6	30	34	2.0	0.33	0.38
	40	36	2.4	0.36	0.41
	50	38	2.7	0.36	0.42
	60	38	2.9	0.39	0.45
7	30	34	2.6	0.43	0.50
	40	38	3.0	0.40	0.46
	50	40	3.4	0.41	0.47
	60	40	3.7	0.45	0.51
8	30	37	3.2	0.45	0.52
	40	39	3.7	0.47	0.54
	50	41	3.9	0.45	0.52
	60	42	4.6	0.50	0.58
9	30	38	3.6	0.48	0.55
	40	41	4.3	0.49	0.57
	50	44	5.2	0.52	0.60
	60	45	5.5	0.52	0.60
10	30	44	6.0	0.60	0.69
	40	46	6.8	0.62	0.71
	50	47	7.6	0.66	0.76
	60	49	8.2	0.66	0.76
11	30	46	8.0	0.73	0.84
	40	48	8.9	0.74	0.86
	50	50	9.8	0.75	0.87
	60	51	10.5	0.78	0.90
12	30	46	10.5	0.96	1.10
	40	48	11.9	0.99	1.15
	50	50	12.7	0.98	1.13
	60	52	14.1	1.00	1.16



PGP Blue Standard Nozzle
Performance Data (P/N 665300)

Nozzle	Pressure PSI	Radius ft.	Flow GPM	Precip in/hr	
				■	▲
1.5	25	29	1.2	0.27	0.32
	35	31	1.4	0.28	0.32
	45	31	1.5	0.30	0.35
	55	32	1.8	0.34	0.39
	65	32	1.9	0.36	0.41
2.0	25	33	1.4	0.25	0.29
	35	33	1.7	0.30	0.35
	45	34	2.0	0.33	0.38
	55	34	2.1	0.35	0.40
	65	32	2.3	0.43	0.50
2.5	25	33	1.7	0.30	0.35
	35	35	2.1	0.33	0.38
	45	35	2.5	0.39	0.45
	55	35	2.6	0.41	0.47
	65	35	2.9	0.46	0.53
3.0	25	35	2.2	0.35	0.40
	35	36	2.7	0.40	0.46
	45	38	3.0	0.40	0.46
	55	39	3.4	0.43	0.50
	65	39	3.7	0.47	0.54
4.0	25	37	3.0	0.42	0.49
	35	39	3.5	0.44	0.51
	45	40	4.0	0.48	0.56
	55	41	4.5	0.52	0.60
	65	41	4.8	0.55	0.63
5.0	25	37	3.7	0.52	0.60
	35	39	4.5	0.57	0.66
	45	42	5.0	0.55	0.63
	55	42	5.7	0.62	0.72
	65	42	6.2	0.68	0.78
6.0	25	38	4.3	0.57	0.66
	35	40	5.6	0.67	0.78
	45	43	6.0	0.62	0.72
	55	44	6.7	0.67	0.77
	65	44	7.3	0.73	0.84
8.0	25	37	6.0	0.84	0.97
	35	41	7.0	0.80	0.93
	45	44	8.0	0.80	0.92
	55	46	9.0	0.82	0.95
	65	46	9.8	0.89	1.03



PGP Gray Low Angle Nozzle
Performance Data (P/N 233200)

Nozzle	Pressure PSI	Radius ft.	Flow GPM	Precip in/hr	
				■	▲
4	30	22	1.4	0.56	0.64
	40	24	1.7	0.57	0.66
	50	26	1.8	0.51	0.59
	60	28	2.0	0.49	0.57
5	30	25	1.6	0.49	0.57
	40	27	1.9	0.50	0.58
	50	28	2.1	0.52	0.60
	60	30	2.3	0.49	0.57
6	30	27	2.1	0.55	0.64
	40	30	2.5	0.53	0.62
	50	33	2.8	0.49	0.57
	60	35	3.0	0.47	0.54
7	30	29	2.8	0.64	0.74
	40	32	3.1	0.58	0.67
	50	35	3.5	0.55	0.64
	60	37	3.8	0.53	0.62
8	30	31	3.4	0.68	0.79
	40	34	3.9	0.65	0.75
	50	37	4.4	0.62	0.71
	60	38	4.7	0.63	0.72
9	30	33	4.3	0.76	0.88
	40	37	5.0	0.70	0.81
	50	40	5.6	0.67	0.78
	60	42	6.1	0.67	0.77
10	40	38	6.5	0.87	1.00
	50	40	7.3	0.88	1.01
	60	42	8.0	0.87	1.01
	70	44	8.6	0.86	0.99

P Blank nozzle plug for turning off selected sprinklers during repairs, maintenance, etc.

Note: All precipitation rates calculated for 180 degree operation. For the precipitation rate for a 360 degree sprinkler, divide by 2. Optimum nozzle performance shown in bold.

PGP ULTRA

APPLICATION
Residential/Light Commercial

RADIUS
17' to 47'

FLOW RATE
0.36 to 14.8 GPM

THIS UPGRADE OF THE FIRST-CLASS PGP IS PACKED WITH NEW FEATURES.

FEATURES

- Models: Shrub, 4", 12"
- Arc setting: 50 to 360 degrees
- Nozzle choices: 22
- Nozzle racks: 1.5 to 8.0 blue, 2.0 LA to 4.5 LA gray, 0.50 to 3.0 black, 6.0 to 13.0 green
- Factory installed rubber cover
- Through-the-top arc adjustment
- Quick check arc mechanism
- Water lubricated gear-drive
- Warranty period: 3 years

ADVANCED FEATURES

- Automatic arc return
 - Non-strippable drive
 - Part- and full-circle in one model
 - Headed and slotted set screw
 - Reclaimed water ID (optional)
 - Drain check valve (optional)
 - Low angle nozzle choices
- = Detailed descriptions on pages 10 and 11

OPERATING SPECIFICATIONS

Radius: 17' to 47'
 Flow rate: 0.36 to 14.8 GPM
 Recommended pressure range: 25 to 70 PSI
 Operating pressure range: 20 to 100 PSI
 Precipitation rates: 0.4 in/hr approx.
 Nozzle trajectory: Std = 25 degrees, Low angle = 13 degrees

FACTORY INSTALLED OPTIONS

Nozzles: 1.5 to 4.0 GPM
 Drain check valve (up to 10' of elevation)
 Reclaimed water ID cover

USER INSTALLED OPTIONS

Drain check valve (up to 10' of elevation; P/N 142300)

NEW NOZZLE SCREW.
 ADJUST THE WAY YOU WANT TO.



Square top nozzle makes installation easy



PGP-00: Overall height: 7½"
 Exposed diameter: 1¾"
 Inlet size: ¾" female NPT



PGP-04: Overall height: 7½"
 Pop-up height: 4"
 Exposed diameter: 1¾"
 Inlet size: ¾" female NPT



PGP-12: Overall height: 17"
 Pop-up height: 12"
 Exposed diameter: 1¾"
 Inlet size: ¾" female NPT



SPECIFICATIONBUILDER

www.hunterindustries.com/PGPULTRA

MODELS	STANDARD FEATURES	FEATURE OPTIONS	NOZZLE OPTIONS
PGP-00 = Shrub	Adjustable arc, plastic riser, 8 standard nozzles, and 4 low-angle nozzles	CV, CV-R	1.5 to 4.0 = Factory installed nozzle number
PGP-04 = 4" pop-up			
PGP-12 = 12" pop-up			

EXAMPLES

PGP-04	4" pop-up, adjustable arc
PGP-04 - 2.5	4" pop-up, adjustable arc, and 2.5 nozzle
PGP-12 - CV-R - 4.0	12" pop-up, adjustable arc, with drain check valve, reclaimed water ID, and 4.0 nozzle

ROTORS

PGP ULTRA CHARTS



PGP Ultra Blue Standard Nozzle
Performance Data (P/N 782900)

Nozzle	Pressure PSI	Radius ft.	Flow GPM	Precip in/hr	
				■	▲
1.5	25	29	1.2	0.27	0.32
	35	31	1.4	0.28	0.32
	45	31	1.5	0.30	0.35
	55	32	1.8	0.34	0.39
65	32	1.9	0.36	0.41	
2.0	25	33	1.4	0.25	0.29
	35	33	1.7	0.30	0.35
	45	34	2.0	0.33	0.38
	55	34	2.1	0.35	0.40
65	32	2.3	0.43	0.50	
2.5	25	33	1.7	0.30	0.35
	35	35	2.1	0.33	0.38
	45	35	2.5	0.39	0.45
	55	35	2.6	0.41	0.47
65	35	2.9	0.46	0.53	
3.0	25	35	2.2	0.35	0.40
	35	36	2.7	0.40	0.46
	45	38	3.0	0.40	0.46
	55	39	3.4	0.43	0.50
65	39	3.7	0.47	0.54	
4.0	25	37	3.0	0.42	0.49
	35	39	3.5	0.44	0.51
	45	40	4.0	0.48	0.56
	55	41	4.5	0.52	0.60
65	41	4.8	0.55	0.63	
5.0	25	37	3.7	0.52	0.60
	35	39	4.5	0.57	0.66
	45	42	5.0	0.55	0.63
	55	42	5.7	0.62	0.72
65	42	6.2	0.68	0.78	
6.0	25	38	4.3	0.57	0.66
	35	40	5.6	0.67	0.78
	45	43	6.0	0.62	0.72
	55	44	6.7	0.67	0.77
65	44	7.3	0.73	0.84	
8.0	25	37	6.0	0.84	0.97
	35	41	7.0	0.80	0.93
	45	44	8.0	0.80	0.92
	55	46	9.0	0.82	0.95
65	46	9.8	0.89	1.03	

PGP Ultra Low Angle Nozzle
Performance Data (P/N 782900)

Nozzle	Pressure PSI	Radius ft.	Flow GPM	Precip in/hr	
				■	▲
2.0 LA	30	25	1.6	0.49	0.57
	40	27	1.9	0.50	0.58
	50	28	2.1	0.52	0.60
	60	30	2.3	0.49	0.57
2.5 LA	30	27	2.1	0.55	0.64
	40	30	2.5	0.53	0.62
	50	33	2.8	0.49	0.57
60	35	3.0	0.47	0.54	
3.5 LA	30	29	2.8	0.64	0.74
	40	32	3.1	0.58	0.67
	50	35	3.5	0.55	0.64
60	37	3.8	0.53	0.62	
4.5 LA	30	29	3.4	0.78	0.90
	40	32	3.9	0.73	0.85
	50	35	4.4	0.69	0.80
60	37	4.7	0.66	0.76	

PGP Ultra High Flow Standard Nozzle
Performance Data (P/N 444800)

Nozzle	Pressure PSI	Radius ft.	Flow GPM	Precip in/hr	
				■	▲
10	40	42	8.4	0.92	1.06
	50	43	9.5	0.99	1.14
	60	45	10.5	1.00	1.15
	70	47	11.4	0.99	1.15
13	40	43	10.9	1.13	1.31
	50	44	12.3	1.22	1.41
	60	45	13.6	1.29	1.49
70	47	14.8	1.29	1.49	
6.0 LA	30	31	4.2	0.84	0.97
	40	35	5.0	0.79	0.91
	50	37	5.8	0.82	0.94
60	39	6.3	0.80	0.92	
8.0 LA	40	37	6.7	0.94	1.09
	50	39	7.7	0.97	1.13
	60	41	8.5	0.97	1.12
70	41	9.2	1.05	1.22	

PGP Ultra 18 Short Radius Nozzle
Performance Data (P/N 466100)

Nozzle	Pressure PSI	Radius ft.	Flow GPM	Precip in/hr	
				■	▲
.50 SR	30	17	0.36	0.24	0.28
	40	17	0.43	0.29	0.33
	50	18	0.50	0.30	0.34
	60	19	0.57	0.30	0.35
1.0 SR	30	17	0.78	0.52	0.60
	40	17	0.90	0.60	0.69
	50	18	1.0	0.59	0.69
60	19	1.1	0.59	0.68	
2.0 SR	30	17	1.4	0.93	1.08
	40	17	1.7	1.13	1.31
	50	18	2.0	1.19	1.37
60	19	2.2	1.17	1.35	

PGP Ultra 25 Short Radius Nozzle
Performance Data (P/N 466100)

Nozzle	Pressure PSI	Radius ft.	Flow GPM	Precip in/hr	
				■	▲
.75 SR	30	23	0.58	0.21	0.24
	40	24	0.68	0.23	0.26
	50	25	0.75	0.23	0.27
	60	26	0.83	0.24	0.27
1.5 SR	30	23	1.1	0.40	0.46
	40	24	1.3	0.43	0.50
	50	25	1.5	0.46	0.53
60	26	1.6	0.46	0.53	
3.0 SR	30	23	2.5	0.91	1.05
	40	24	2.7	0.90	1.04
	50	25	3.0	0.92	1.07
60	26	3.1	0.88	1.02	

Note: All precipitation rates calculated for 180 degree operation. For the precipitation rate for a 360 degree sprinkler, divide by 2. Optimum nozzle performance shown in bold.

I-20

APPLICATION
Residential/Commercial

RADIUS
17' to 46'

FLOW RATE
0.36 to 14.8 GPM

THE I-20 IS THE ROTOR THAT'S GOT ALL THE FEATURES YOU NEED.

FEATURES

- Models: Shrub, 4", 6", 12"
- Models (stainless riser): 4", 6"
- Arc setting: 50 to 360 degrees
- Nozzle choices: 22
- Nozzle racks: 1.5 to 8.0 blue, 2.0 LA to 4.5 LA gray, 0.50 to 3.0 black, 6.0 to 13.0 green
- Factory installed rubber cover
- Through-the-top arc adjustment
- Quick check arc mechanism
- Water lubricated gear-drive
- Warranty period: 5 years

ADVANCED FEATURES

- Automatic arc return
- Non-strippable drive
- Part- and full-circle in one model
- Headed and slotted set screw
- FloStop® control
- = Detailed descriptions on pages 10 and 11
- Reclaimed water ID (optional)
- Stainless steel riser (optional)
- Drain check valve (up to 10' of elevation)
- Low angle nozzle choices

OPERATING SPECIFICATIONS

Radius: 17' to 46'
 Flow Rate: 0.36 to 14.8 GPM
 Recommended pressure range: 30 to 70 PSI
 Operating pressure range: 20 to 100 PSI
 Precipitation rates: 0.4 in/hr approx.
 Nozzle trajectory: Std = 25 degrees, Low angle = 13 degrees

FACTORY INSTALLED OPTIONS

Nozzles: 1.5 to 4.0
 Reclaimed water ID cover



I-20-00: Overall height: 7 3/4"
 Exposed diameter: 1 3/4"
 Inlet size: 3/4" female NPT

I-20-04: Overall height: 7 1/2"
 Pop-up height: 4"
 Exposed diameter: 1 3/4"
 Inlet size: 3/4" female NPT

I-20-06: Overall height: 9"
 Pop-up height: 6"
 Exposed diameter: 1 3/4"
 Inlet size: 3/4" female NPT

I-20-12: Overall height: 17"
 Pop-up height: 12"
 Exposed diameter: 1 3/4"
 Inlet size: 3/4" female NPT

SPECIFICATIONBUILDER

www.hunterindustries.com/i20

MODELS	STANDARD FEATURES	FEATURE OPTIONS	NOZZLE OPTIONS
I-20-00 = Shrub	Adjustable arc, plastic riser, check valve, 8 standard nozzles, and 4 low-angle nozzles	R	1.5 to 4.0 = Factory installed nozzle number
I-20-04 = 4" pop-up		NCV, R	
I-20-06 = 6" pop-up		R	
I-20-12 = 12" pop-up		R	

MODELS	STANDARD FEATURES	FEATURE OPTIONS	NOZZLE OPTIONS
I-20-04-SS = 4" pop-up	Adjustable arc, stainless steel riser, check valve, 8 standard nozzles, and 4 low-angle nozzles	NCV, R	1.5 to 4.0 = Factory installed nozzle number
I-20-06-SS = 6" pop-up		R	

EXAMPLES

I-20-04	4" pop-up, adjustable arc
I-20-12 - NCV - R - 4.0	12" pop-up, adjustable arc, without check valve, with reclaimed water ID, and 4.0 nozzle
I-20-06-SS - R - 3.0	6" pop-up, adjustable arc, stainless steel, reclaimed water ID, and 3.0 nozzle

I-20 CHARTS



I-20 Blue Standard Nozzle Performance Data (P/N 782900)

Nozzle	Pressure PSI	Radius ft.	Flow GPM	Precip in/hr	
				■	▲
1.5	25	29	1.2	0.27	0.32
	35	31	1.4	0.28	0.32
	45	31	1.5	0.30	0.35
	55	32	1.8	0.34	0.39
2.0	65	32	1.9	0.36	0.41
	25	33	1.4	0.25	0.29
	35	33	1.7	0.30	0.35
	45	34	2.0	0.33	0.38
2.5	55	34	2.1	0.35	0.40
	65	32	2.3	0.43	0.50
	25	33	1.7	0.30	0.35
	35	35	2.1	0.33	0.38
3.0	45	35	2.5	0.39	0.45
	55	35	2.6	0.41	0.47
	65	35	2.9	0.46	0.53
	25	35	2.2	0.35	0.40
4.0	35	36	2.7	0.40	0.46
	45	38	3.0	0.40	0.46
	55	39	3.4	0.43	0.50
	65	39	3.7	0.47	0.54
5.0	25	37	3.0	0.42	0.49
	35	39	3.5	0.44	0.51
	45	40	4.0	0.48	0.56
	55	41	4.5	0.52	0.60
6.0	65	41	4.8	0.55	0.63
	25	37	3.7	0.52	0.60
	35	39	4.5	0.57	0.66
	45	42	5.0	0.55	0.63
8.0	55	42	5.7	0.62	0.72
	65	42	6.2	0.68	0.78
	25	38	4.3	0.57	0.66
	35	40	5.6	0.67	0.78
10	45	43	6.0	0.62	0.72
	55	44	6.7	0.67	0.77
	65	44	7.3	0.73	0.84
	25	37	6.0	0.84	0.97
13	35	41	7.0	0.80	0.93
	45	44	8.0	0.80	0.92
	55	46	9.0	0.82	0.95
	65	46	9.8	0.89	1.03

I-20 Low Angle Nozzle Performance Data (P/N 782900)

Nozzle	Pressure PSI	Radius ft.	Flow GPM	Precip in/hr	
				■	▲
2.0 LA	30	25	1.6	0.49	0.57
	40	27	1.9	0.50	0.58
	50	28	2.1	0.52	0.60
2.5 LA	60	30	2.3	0.49	0.57
	30	27	2.1	0.55	0.64
	40	30	2.5	0.53	0.62
3.5 LA	50	33	2.8	0.49	0.57
	60	35	3.0	0.47	0.54
	30	29	2.8	0.64	0.74
4.5 LA	40	32	3.1	0.58	0.67
	50	35	3.5	0.55	0.64
	60	37	3.8	0.53	0.62
6.0 LA	30	29	3.4	0.78	0.90
	40	32	3.9	0.73	0.85
	50	35	4.4	0.69	0.80
8.0 LA	60	37	4.7	0.66	0.76

I-20 High Flow Nozzles Performance Data (P/N 444800)

Nozzle	Pressure PSI	Radius ft.	Flow GPM	Precip in/hr	
				■	▲
10	40	42	8.4	0.92	1.06
	50	43	9.5	0.99	1.14
	60	45	10.5	1.00	1.15
	70	47	11.4	0.99	1.15
13	40	43	10.9	1.13	1.31
	50	44	12.3	1.22	1.41
	60	45	13.6	1.29	1.49
	70	47	14.8	1.29	1.49
6.0 LA	30	31	4.2	0.84	0.97
	40	35	5.0	0.79	0.91
	50	37	5.8	0.82	0.94
	60	39	6.3	0.80	0.92
8.0 LA	40	37	6.7	0.94	1.09
	50	39	7.7	0.97	1.13
	60	41	8.5	0.97	1.12
	70	41	9.2	1.05	1.22

I-20 18' Short Radius Nozzle Performance Data (P/N 466100)

Nozzle	Pressure PSI	Radius ft.	Flow GPM	Precip in/hr	
				■	▲
.50 SR	30	17	0.36	0.24	0.28
	40	17	0.43	0.29	0.33
	50	18	0.50	0.30	0.34
1.0 SR	60	19	0.57	0.30	0.35
	30	17	0.78	0.52	0.60
	40	17	0.90	0.60	0.69
2.0 SR	50	18	1.0	0.59	0.69
	60	19	1.1	0.59	0.68
	30	17	1.4	0.93	1.08
3.0 SR	40	17	1.7	1.13	1.31
	50	18	2.0	1.19	1.37
	60	19	2.2	1.17	1.35

I-20 25' Short Radius Nozzle Performance Data (P/N 466100)

Nozzle	Pressure PSI	Radius ft.	Flow GPM	Precip in/hr	
				■	▲
.75 SR	30	23	0.58	0.21	0.24
	40	24	0.68	0.23	0.26
	50	25	0.75	0.23	0.27
1.5 SR	60	26	0.83	0.24	0.27
	30	23	1.1	0.40	0.46
	40	24	1.3	0.43	0.50
3.0 SR	50	25	1.5	0.46	0.53
	60	26	1.6	0.46	0.53
	30	23	2.5	0.91	1.05
4.5 SR	40	24	2.7	0.90	1.04
	50	25	3.0	0.92	1.07
	60	26	3.1	0.88	1.02

Note: All precipitation rates calculated for 180 degree operation. For the precipitation rate for a 360 degree sprinkler, divide by 2. Optimum nozzle performance shown in bold.

I-25

APPLICATION
Commercial/Municipal

RADIUS
37' to 71'

FLOW RATE
3.8 to 31.5 GPM

THIS RUGGED ROTOR CAN STAND UP TO ANY COMMERCIAL JOB.

FEATURES

- Models: 4", 6"
- Arc setting: 50 to 360 degrees
- Nozzle choices: 12
- Nozzle range: #4 to #28
- Factory installed rubber cover
- Through-the-top arc adjustment
- Quick check arc mechanism
- Water lubricated gear-drive
- Warranty period: 5 years

ADVANCED FEATURES

- Automatic arc return
 - Non-strippable drive
 - Part- and full-circle in one model
 - Color coded nozzles
 - Reclaimed water ID (optional)
 - Stainless steel riser (optional)
 - Drain check valve (up to 10' of elevation)
- = Detailed descriptions on pages 10 and 11

OPERATING SPECIFICATIONS

Radius: 37' to 71'
 Flow rate: 3.8 to 31.5 GPM
 Recommended pressure range: 40 to 100 PSI
 Operating pressure range: 40 to 100 PSI
 Precipitation rates: 0.4 in/hr approx.
 Nozzle trajectory: 25 degrees

FACTORY INSTALLED OPTIONS

Nozzles: #4 to #28
 Reclaimed water ID cover
 High speed rotation model (stainless steel only)



I-25-04: Overall height: 7 7/8"
 Pop-up height: 4"
 Exposed diameter: 1 1/4"
 Inlet size: 1" female NPT



I-25-06: Overall height: 10 1/4"
 Pop-up height: 6"
 Exposed diameter: 1 1/4"
 Inlet size: 1" female NPT



SPECIFICATIONBUILDER

www.hunterindustries.com/I25

MODELS	STANDARD FEATURES	FEATURE OPTIONS	NOZZLE OPTIONS
I-25-04 = 4" pop-up I-25-06 = 6" pop-up	Adjustable arc, plastic riser, check valve, and 5 nozzles	R, B	#4 to #28 = Factory installed nozzle number
I-25-04-SS = 4" pop-up I-25-06-SS = 6" pop-up	Adjustable arc, stainless steel riser, check valve, and 5 nozzles	R, HS, HS-R, B	#4 to #28 = Factory installed nozzle number

EXAMPLES

I-25-04	4" pop-up, adjustable arc
I-25-04-SS - R - 18	4" pop-up, adjustable arc, stainless steel riser, reclaimed water ID, and #18 nozzle
I-25-06-SS	6" pop-up, adjustable arc, stainless steel riser

ROTORS

I-25 CHARTS



I-25 Nozzle Performance Data

Nozzle	Pressure PSI	Radius ft.	Flow GPM	Precip in/hr	
				■	▲
4 Yellow	40	40	3.8	0.46	0.53
	50	41	4.3	0.49	0.57
	60	42	4.7	0.51	0.59
	70	43	5.1	0.53	0.61
5 White	40	43	4.4	0.46	0.53
	50	44	4.8	0.48	0.55
	60	45	5.3	0.50	0.58
	70	46	5.6	0.51	0.59
7 Orange*	40	45	6.6	0.63	0.72
	50	47	7.0	0.61	0.70
	60	48	7.5	0.63	0.72
	70	49	7.9	0.63	0.73
8 Lt. Brown	40	47	7.7	0.67	0.77
	50	49	8.3	0.67	0.77
	60	50	9.2	0.71	0.82
	70	51	9.9	0.73	0.85
10 Lt. Green*	50	51	10.1	0.75	0.86
	60	52	11.1	0.79	0.91
	70	53	12.1	0.83	0.96
	80	54	12.9	0.85	0.98
13 Lt. Blue	50	53	11.2	0.77	0.89
	60	54	12.3	0.81	0.94
	70	55	13.3	0.85	0.98
	80	55	14.3	0.91	1.05
15 Gray*	50	56	13.4	0.82	0.95
	60	57	14.3	0.85	0.98
	70	57	15.2	0.90	1.04
	80	58	16.4	0.94	1.08
18 Red	50	58	14.5	0.83	0.96
	60	59	15.7	0.87	1.00
	70	62	16.9	0.85	0.98
	80	63	18.2	0.88	1.02
20 Dk. Brown*	60	62	17.8	0.89	1.03
	70	63	19.2	0.93	1.08
	80	64	20.5	0.96	1.11
	90	65	21.8	0.99	1.15
23 Dk. Green	60	64	21.9	1.03	1.19
	70	65	23.6	1.08	1.24
	80	66	25.6	1.13	1.31
	90	67	27.0	1.16	1.34
25 Dk. Blue*	60	66	23.5	1.04	1.20
	70	68	25.5	1.06	1.23
	80	69	28.0	1.13	1.31
	90	70	29.5	1.16	1.34
28 Black	70	68	26.9	1.12	1.29
	80	70	28.7	1.13	1.30
	90	71	30.6	1.17	1.35
	100	71	31.5	1.20	1.39

I-25 High-Speed Nozzle Performance Data

Nozzle	Pressure PSI	Radius ft.	Flow GPM	Precip in/hr	
				■	▲
4 Yellow	40	37	3.8	0.53	0.62
	50	38	4.3	0.57	0.66
	60	38	4.7	0.63	0.72
	70	39	5.2	0.66	0.76
5 White	40	38	4.4	0.59	0.68
	50	39	4.8	0.61	0.70
	60	40	5.5	0.66	0.76
	70	41	6.0	0.69	0.79
7 Orange*	40	40	6.1	0.73	0.85
	50	41	6.9	0.79	0.91
	60	42	7.5	0.82	0.95
	70	44	8.1	0.81	0.93
8 Lt. Brown	40	42	7.2	0.79	0.91
	50	43	8.1	0.84	0.97
	60	44	8.9	0.88	1.02
	70	45	9.8	0.93	1.08
10 Lt. Green*	50	46	10.1	0.92	1.06
	60	48	11.1	0.93	1.07
	70	49	12.1	0.97	1.12
	80	50	12.9	0.99	1.15
13 Lt. Blue	50	48	11.2	0.94	1.08
	60	49	12.3	0.99	1.14
	70	51	13.3	0.98	1.14
	80	51	14.3	1.06	1.22
15 Gray*	50	49	13.4	1.07	1.24
	60	51	14.3	1.06	1.22
	70	53	15.2	1.04	1.20
	80	54	16.4	1.08	1.25
18 Red	50	50	14.5	1.12	1.29
	60	53	15.7	1.08	1.24
	70	55	16.9	1.08	1.24
	80	57	18.2	1.08	1.25
20 Dk. Brown*	60	53	17.8	1.22	1.41
	70	56	19.2	1.18	1.36
	80	58	20.5	1.17	1.35
	90	59	21.8	1.21	1.39
23 Dk. Green	60	56	21.9	1.34	1.55
	70	58	23.6	1.35	1.56
	80	60	25.6	1.37	1.58
	90	61	27.0	1.40	1.61
25 Dk. Blue*	60	58	23.5	1.34	1.55
	70	62	25.5	1.28	1.47
	80	64	28.0	1.32	1.52
	90	66	29.5	1.30	1.51
28 Black	70	60	26.9	1.44	1.66
	80	62	28.7	1.44	1.66
	90	65	30.6	1.39	1.61
	100	67	31.5	1.35	1.56

* 5 standard nozzles included with each sprinkler.
 Note: All precipitation rates calculated for 180 degree operation. For the precipitation rate for a 360 degree sprinkler, divide by 2.

I-35

APPLICATION
Commercial/Municipal

RADIUS
47' to 71'

FLOW RATE
7.7 to 31.5 GPM

THE I-35 IS THE ONLY 1" ROTOR WITH EVERYTHING YOU NEED BUILT RIGHT IN.

FEATURES

- Model: 6"
- Arc setting: 50 to 360 degrees
- Nozzle choices: 8
- Nozzle range: #9 to #30
- Factory installed rubber cover
- Through-the-top arc adjustment
- Quick check arc mechanism
- Water lubricated gear-drive
- Warranty period: 5 years

ADVANCED FEATURES

- Automatic arc return
 - Non-strippable drive
 - Part- and full-circle in one model
 - Headed and slotted set screw
 - FloStop® control
 - Color coded nozzles
 - Reclaimed water ID (optional)
 - Stainless steel riser (optional)
 - Drain check valve (up to 10' of elevation)
- = Detailed descriptions on pages 10 and 11

OPERATING SPECIFICATIONS

Radius: 47' to 71'
 Flow Rate: 7.7 to 31.5 GPM
 Recommended pressure range: 40 to 100 PSI
 Operating pressure range: 40 to 100 PSI
 Precipitation rates: 0.4 in/hr approx.
 Nozzle trajectory: 25 degrees

FACTORY INSTALLED OPTIONS

Nozzles: #9 to #30
 Reclaimed water ID cover
 High speed rotation model (stainless steel only)



Triple port nozzle design



I-35-06: Overall height: 10³/₈"
 Pop-up height: 6"
 Exposed diameter: 1¹/₈"
 Inlet size: 1" female NPT



SPECIFICATIONBUILDER

www.hunterindustries.com/l35

MODEL	STANDARD FEATURES	FEATURE OPTIONS	NOZZLE OPTIONS
I-35-06 = 6" pop-up	Adjustable arc, plastic riser, check valve, and 8 nozzles	R, B	#9 to #30 = Factory installed nozzle number

MODEL	STANDARD FEATURES	FEATURE OPTIONS	NOZZLE OPTIONS
I-35-06-SS = 6" pop-up	Adjustable arc, stainless steel riser, check valve, and 8 nozzles	R, HS, HS-R, B	#9 to #30 = Factory installed nozzle number

EXAMPLES

I-35-06	6" pop-up, adjustable arc
I-35-06-SS - R - 18	6" pop-up, adjustable arc, stainless steel riser, reclaimed water ID, and #18 nozzle
I-35-06-SS	6" pop-up, adjustable arc, stainless steel riser

ROTORS

I-35 CHARTS



I-35 Nozzle Performance Data

Nozzle	Pressure PSI	Radius ft.	Flow GPM	Precip in/hr	
				■	▲
9 Lt. Brown	40	47	7.7	0.67	0.77
	50	49	8.3	0.67	0.77
	60	50	9.2	0.71	0.82
	70	50	9.9	0.73	0.85
12 Lt. Blue	50	53	11.2	0.77	0.89
	60	54	12.3	0.81	0.94
	70	55	13.3	0.85	0.98
	80	55	14.3	0.91	1.05
15 Gray	50	56	13.4	0.82	0.95
	60	57	14.3	0.85	0.98
	70	57	15.2	0.90	1.04
	80	58	16.4	0.94	1.08
18 Red	50	58	14.5	0.83	0.96
	60	59	15.7	0.87	1.00
	70	62	16.9	0.85	0.98
	80	63	18.2	0.88	1.02
21 Dk. Brown	60	62	17.8	0.89	1.03
	70	63	19.2	0.93	1.08
	80	64	20.5	0.96	1.11
	90	65	21.8	0.99	1.15
24 Dk. Green	60	64	21.9	1.03	1.19
	70	65	23.6	1.08	1.24
	80	66	25.6	1.13	1.31
	90	67	27.0	1.16	1.34
27 Dk. Blue	60	66	23.5	1.04	1.20
	70	68	25.5	1.06	1.23
	80	69	28.0	1.13	1.31
	90	70	29.5	1.16	1.34
30 Black	70	68	26.9	1.12	1.29
	80	70	28.7	1.13	1.30
	90	71	30.6	1.17	1.35
	100	71	31.5	1.20	1.39

I-35 High-Speed Nozzle Performance Data

Nozzle	Pressure PSI	Radius ft.	Flow GPM	Precip in/hr	
				■	▲
9 Lt. Brown	40	42	7.7	0.84	0.97
	50	43	8.3	0.86	1.00
	60	44	9.2	0.91	1.06
	70	45	9.9	0.94	1.09
12 Lt. Blue	50	48	11.2	0.94	1.08
	60	49	12.3	0.99	1.14
	70	51	13.3	0.98	1.14
	80	51	14.3	1.06	1.22
15 Gray	50	49	13.4	1.07	1.24
	60	51	14.3	1.06	1.22
	70	53	15.2	1.04	1.20
	80	54	16.4	1.08	1.25
18 Red	50	50	14.5	1.12	1.29
	60	53	15.7	1.08	1.24
	70	55	16.9	1.08	1.24
	80	57	18.2	1.08	1.25
21 Dk. Brown	60	53	17.8	1.22	1.41
	70	56	19.2	1.18	1.36
	80	58	20.5	1.17	1.35
	90	59	21.8	1.21	1.39
24 Dk. Green	60	56	21.9	1.34	1.55
	70	58	23.6	1.35	1.56
	80	60	25.6	1.37	1.58
	90	61	27.0	1.40	1.61
27 Dk. Blue	60	58	23.5	1.34	1.55
	70	62	25.5	1.28	1.47
	80	64	28.0	1.32	1.52
	90	66	29.5	1.30	1.51
30 Black	70	60	26.9	1.44	1.66
	80	62	28.7	1.44	1.66
	90	65	30.6	1.39	1.61
	100	67	31.5	1.35	1.56

* 5 standard nozzles included with each sprinkler.

Note: All precipitation rates calculated for 180 degree operation. For the precipitation rate for a 360 degree sprinkler, divide by 2.

I-40

APPLICATION
Commercial/High-End Municipal

RADIUS
45' to 76'

FLOW RATE
7.0 to 33.7 GPM

FOR SPORTS FIELDS AND PARKS, I-40 DELIVERS PROFESSIONAL RESULTS.

FEATURES

- Models (stainless riser): 4", 6"
- Arc setting: 50 to 360 degrees
- Nozzle choices: 6
- Nozzle ranges: #40 to #45, #15 to #28
- Factory installed rubber cover
- Through-the-top arc adjustment
- Quick check arc mechanism
- Water lubricated gear-drive
- Warranty period: 5 years

ADVANCED FEATURES

- Automatic arc return
 - Non-strippable drive
 - Part- and full-circle in one model
 - Opposing nozzle 360° model
 - Reclaimed water ID (optional)
 - Stainless steel riser
 - Drain check valve (up to 15' of elevation)
- = Detailed descriptions on pages 10 and 11

OPERATING SPECIFICATIONS

Radius: 45' to 76'
 Flow rate: 7.0 to 33.7 GPM
 Recommended pressure range: 40 to 100 PSI
 Operating pressure range: 40 to 100 PSI
 Precipitation rates: 0.4 in/hr approx.
 Nozzle trajectory: 25 degrees

FACTORY INSTALLED OPTIONS

Nozzles: #40 to #45, #15 to #28
 Reclaimed water ID cover
 High speed rotation model

USER INSTALLED OPTIONS

Turf cup kit (P/N 460000)



Opposing nozzle 360° model



I-40-04: Overall height: 7 1/8"
 Pop-up height: 4"
 Exposed diameter: 2"
 Inlet size: 1" female NPT



I-40-06: Overall height: 10 1/4"
 Pop-up height: 6"
 Exposed diameter: 2"
 Inlet size: 1" female NPT



SPECIFICATIONBUILDER

www.hunterindustries.com/I40

MODELS	STANDARD FEATURES	FEATURE OPTIONS	NOZZLE OPTIONS
I-40-04-SS = 4" pop-up	Adjustable arc, stainless steel riser, check valve, and 6 nozzles	ON, ON-R, HS, HS-R, R, B ON = Full circle opposing nozzles ON-R = Full circle opposing nozzles and reclaimed water ID HS = High speed HS-R = High speed and reclaimed water ID R = Reclaimed water ID B = BSP inlet threads	#40 to #45 = Factory installed nozzle number #15 to #28 = Factory installed nozzle number
I-40-06-SS = 6" pop-up			

EXAMPLES

I-40-04-SS	4" pop-up, adjustable arc
I-40-04-SS - ON-R - 44	4" pop-up, adjustable arc, full circle opposing nozzles, reclaimed water ID, and #44 nozzle
I-40-06-SS - 43	6" pop-up, adjustable arc, and #43 nozzle

ROTORS

I-40 CHARTS

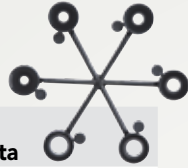

I-40 Nozzle Performance Data

Nozzle	Pressure PSI	Radius ft.	Flow GPM	Precip in/hr	
				■	▲
40	40	45	7.0	0.67	0.77
	50	46	8.0	0.73	0.84
	60	46	8.5	0.77	0.89
41	50	50	10.2	0.79	0.91
	60	51	11.1	0.82	0.95
	70	52	12.1	0.86	0.99
	80	53	13.0	0.89	1.03
42	50	51	11.0	0.81	0.94
	60	53	12.3	0.84	0.97
	70	55	13.1	0.83	0.96
43	80	56	13.9	0.85	0.99
	50	56	13.5	0.83	0.96
	60	57	15.1	0.89	1.03
44	70	59	16.1	0.89	1.03
	80	61	17.5	0.91	1.05
	60	63	20.0	0.97	1.12
45	70	65	21.8	0.99	1.15
	80	66	23.4	1.03	1.19
	90	67	24.9	1.07	1.23
45	60	66	22.7	1.00	1.16
	70	68	24.7	1.03	1.19
	80	69	26.4	1.07	1.23
	90	70	28.2	1.11	1.28

I-40 High Speed Nozzle Performance Data

Nozzle	Pressure PSI	Radius ft.	Flow GPM	Precip in/hr	
				■	▲
40	40	41	7.0	0.80	0.93
	50	42	8.0	0.87	1.01
	60	42	8.5	0.93	1.07
41	50	44	10.2	1.01	1.17
	60	44	11.1	1.10	1.27
	70	45	12.1	1.15	1.33
	80	46	13.0	1.18	1.37
42	50	46	11.0	1.00	1.16
	60	47	12.3	1.07	1.24
	70	49	13.1	1.05	1.21
43	80	50	13.9	1.07	1.24
	50	51	13.5	1.00	1.15
	60	52	15.1	1.07	1.24
44	70	52	16.1	1.15	1.32
	80	53	17.5	1.20	1.38
	60	58	20.0	1.14	1.32
45	70	58	21.8	1.25	1.44
	80	60	23.4	1.25	1.44
	90	60	24.9	1.33	1.54
45	60	60	22.7	1.21	1.40
	70	62	24.7	1.24	1.43
	80	64	26.4	1.24	1.43
	90	65	28.2	1.28	1.48

I-40 Dual Opposing Nozzle Performance Data

Nozzle	Pressure PSI	Radius ft.	Flow GPM	Precip in/hr	
				■	▲
15 Gray	50	52	13.0	0.46	0.53
	60	54	13.2	0.44	0.50
	70	56	14.4	0.44	0.51
	80	57	15.5	0.46	0.53
18 Red	50	58	13.7	0.39	0.45
	60	59	15.2	0.42	0.49
	70	60	16.6	0.44	0.51
	80	62	17.8	0.45	0.51
20 Dk. Brown	60	63	19.1	0.46	0.53
	70	64	20.9	0.49	0.57
	80	66	22.3	0.49	0.57
	90	66	23.9	0.53	0.61
23 Dk. Green	60	65	20.4	0.46	0.54
	70	66	22.3	0.49	0.57
	80	67	24.0	0.51	0.59
25 Dk. Blue*	90	68	25.6	0.53	0.62
	60	66	22.0	0.49	0.56
	70	68	24.0	0.50	0.58
28 Black	80	69	25.9	0.52	0.60
	90	70	27.2	0.53	0.62
	70	70	28.9	0.57	0.66
28 Black	80	72	30.9	0.57	0.66
	90	74	32.9	0.58	0.67
	100	76	33.7	0.56	0.65
	90	74	32.9	0.58	0.67

* Factory-installed nozzle

Note: All precipitation rates are calculated for 180 degree operation. For the precipitation rate for a 360 degree sprinkler, divide by 2. Precipitation rates for the ON model are calculated at 360 degrees.

I-60

APPLICATION
Low Pressure Commercial/Municipal

RADIUS
50' to 67'

FLOW RATE
6.5 to 20.8 GPM

THE I-60 IS IDEAL FOR LARGE-AREA TURF SITES WITH LOWER PRESSURES.

FEATURES

- Model (stainless riser): 3"
- Arc setting:
ADS: 40–360 degrees
36S: full-circle only
- Nozzle choices: 6
- Nozzle range: #7 to #20
- Standard factory installed nozzle: #13
- Factory installed rubber cover
- Through-the-top arc adjustment
- Quick check arc mechanism
- Water lubricated gear-drive
- Warranty period: 5 years

ADVANCED FEATURES

- Color coded nozzles
- Reclaimed water ID (optional)
- Stainless steel riser
- Drain check valve (up to 10' of elevation)
- = Detailed descriptions on pages 10 and 11

OPERATING SPECIFICATIONS

Radius: 50' to 67'
 Flow rate: 6.5 to 20.8 GPM
 Recommended pressure range: 40 to 60 PSI
 Operating pressure range: 20 to 100 PSI
 Precipitation rates: 0.4 in/hr approx.
 Nozzle trajectory: 25 degrees

FACTORY INSTALLED OPTIONS

Nozzles: #7 to #20
 Reclaimed water ID cover



I-60: Overall height: ADS/36S: 8³/₈"
 Pop-up height: 3"
 Exposed diameter: 1³/₄"
 Inlet size: 1" female NPT



SPECIFICATIONBUILDER

www.hunterindustries.com/160

MODEL	STANDARD FEATURES	FEATURE OPTIONS	NOZZLE OPTIONS
I-60 = 3" pop-up	Stainless steel riser, check valve, and 6 nozzles	ADS, ARS, 36S, 3RS, B	#7 to #20 = Factory installed nozzle number

EXAMPLES

I-60 - ADS	3" pop-up, adjustable arc
I-60 - 36S - 10	3" pop-up, full circle, and #10 nozzle
I-60 - 3RS - 7	3" pop-up, full circle, reclaimed water ID and #7 nozzle

ROTORS

I-60 CHARTS



I-60 ADS Nozzle Performance Data

Nozzle	Pressure PSI	Radius ft.	Flow GPM	Precip in/hr	
				■	▲
7 Orange	40	50	6.5	0.50	0.58
	50	52	7.1	0.51	0.58
	60	54	7.7	0.51	0.59
10 Lt. Green	40	53	8.5	0.58	0.67
	50	56	9.5	0.58	0.67
	60	58	10.2	0.58	0.67
13 Lt. Blue*	40	56	10.5	0.64	0.74
	50	58	12.1	0.69	0.80
	60	60	13.0	0.70	0.80
15 Gray	40	58	12.5	0.72	0.83
	50	60	13.9	0.74	0.86
	60	62	15.1	0.76	0.87
18 Red	40	59	15.6	0.86	1.00
	50	62	17.5	0.88	1.01
	60	65	18.6	0.85	0.98
20 Dk. Brown	40	62	17.5	0.88	1.01
	50	64	19.1	0.90	1.04
	60	66	20.4	0.90	1.04

I-60 36S Nozzle Performance Data

Nozzle	Pressure PSI	Radius ft.	Flow GPM	Precip in/hr	
				■	▲
7 Orange	40	51	6.5	0.24	0.28
	50	54	7.5	0.25	0.29
	60	56	8.0	0.25	0.28
10 Lt. Green	40	53	8.5	0.29	0.34
	50	56	9.5	0.29	0.34
	60	58	10.2	0.29	0.34
13 Lt. Blue*	40	56	10.5	0.32	0.37
	50	58	12.4	0.35	0.41
	60	60	13.0	0.35	0.40
15 Gray	40	58	12.5	0.36	0.41
	50	60	14.0	0.37	0.43
	60	62	15.1	0.38	0.44
18 Red	40	59	15.6	0.43	0.50
	50	62	17.7	0.44	0.51
	60	65	18.9	0.43	0.50
20 Dk. Brown	40	62	17.5	0.44	0.51
	50	64	19.1	0.45	0.52
	60	67	20.8	0.45	0.51

* Factory-installed nozzle

Note: All precipitation rates calculated for 180-degree operation. For the precipitation rate for a 360-degree sprinkler, divide by 2. Precipitation rates for the 36S model are calculated at 360 degrees.

I-90

APPLICATION
Large Radius Commercial/Municipal

RADIUS
63' to 101'

FLOW RATE
22 to 83 GPM

HUNTER'S LONGEST DISTANCE ROTOR IS PERFECT FOR PARKS AND SPORTS FIELDS.

FEATURES

- Model: 3"
- Arc setting: 40 to 360 degrees, 360 degrees
- Nozzle choices: 8
- Nozzle range: #25 to #73
- Through-the-top arc adjustment
- Quick check arc mechanism
- Water lubricated gear-drive
- Standard factory installed nozzle: #53
- Factory installed rubber logo cap
- Warranty period: 5 years

ADVANCED FEATURES

- Opposing nozzle 360° model
- Color coded nozzles
- Reclaimed water ID (optional)
- Drain check valve (up to 9' of elevation)
- = Detailed descriptions on pages 10 and 11

OPERATING SPECIFICATIONS

Radius: 63' to 101'
 Flow rate: 22 to 83 GPM
 Recommended pressure range: 60 to 110 PSI
 Operating pressure range: 50 to 120 PSI
 Precipitation rates: 0.75 in/hr approx.
 Nozzle trajectory: 22.5 degrees

FACTORY INSTALLED OPTIONS

Nozzles: #25 to #73
 Reclaimed water ID cover

USER INSTALLED OPTIONS

Rubber Cover Kit I90-ADV (P/N 234200)
 Rubber Cover Kit I90-36V (P/N 234201)
 Turf Cup Kit (P/N 467955)



I-90: Overall height: ADV/36V: 11"
 Pop-up height: 3"
 Exposed diameter: 3½"
 Inlet size: 1½" female NPT



Turf cup kit (P/N 467955)



Rubber cover kits
 (P/N 234200, P/N 234201)



SPECIFICATIONBUILDER

www.hunterindustries.com/I90

MODEL	STANDARD FEATURES	FEATURE OPTIONS	NOZZLE OPTIONS
I-90 = 3" pop-up	Plastic riser, check valve, and 8 nozzles	ADV, ARV, 36V, 3RV, B	#25 to #73 = Factory installed nozzle number

EXAMPLES

I-90 - ADV	3" pop-up, adjustable arc
I-90 - 36V - 43	3" pop-up, full circle, opposing nozzles, and #43 nozzle
I-90 - 3RV - 63	3" pop-up, full circle, opposing nozzles, reclaimed water ID, and #63 nozzle

ROTORS

I-90 CHARTS



I-90-ADV Nozzle Performance Data

Nozzle	Pressure PSI	Radius ft.	Flow GPM	Precip in/hr	
				■	▲
25 Lt. Blue NEW	60	63	22.0	1.07	1.23
	70	64	24.9	1.17	1.35
	80	65	27.5	1.25	1.45
	90	67	28.8	1.24	1.43
	100	68	30.6	1.27	1.47
33 Gray	60	67	30.7	1.32	1.52
	70	67	33.1	1.42	1.64
	80	68	35.5	1.48	1.71
	90	69	37.7	1.52	1.76
	100	70	39.8	1.56	1.81
38 Red	60	69	34.0	1.37	1.59
	70	70	36.9	1.45	1.67
	80	72	39.8	1.48	1.71
	90	73	42.3	1.53	1.76
	100	75	44.1	1.51	1.74
43 Dk. Brown	60	70	38.7	1.52	1.76
	70	71	42.0	1.60	1.85
	80	72	44.5	1.65	1.91
	90	73	47.6	1.72	1.99
	100	73	48.3	1.74	2.01
48 Dk. Green	70	75	47.0	1.61	1.86
	80	77	50.2	1.63	1.88
	90	79	53.3	1.64	1.90
	100	81	56.0	1.64	1.90
	53 Dk. Blue*	70	79	48.5	1.50
80		81	53.4	1.57	1.81
90		85	57.0	1.52	1.75
100		86	59.5	1.55	1.79
63 Black		70	84	60.9	1.66
	80	86	63.8	1.66	1.92
	90	88	66.5	1.65	1.91
	100	90	69.8	1.66	1.92
	73 Orange NEW	80	90	66.9	1.59
90		92	69.7	1.59	1.83
100		95	72.8	1.55	1.79
110		98	76.2	1.53	1.76

I-90-36V Nozzle Performance Data

Nozzle	Pressure PSI	Radius ft.	Flow GPM	Precip in/hr	
				■	▲
25 Lt. Blue NEW	60	69	25.5	0.52	0.60
	70	71	27.8	0.53	0.61
	80	73	30.2	0.55	0.63
	90	75	31.7	0.54	0.63
	100	77	33.9	0.55	0.64
33 Gray	60	71	29.8	0.57	0.66
	70	74	32.2	0.57	0.65
	80	76	34.4	0.57	0.66
	90	78	36.8	0.58	0.67
	100	80	38.6	0.58	0.67
38 Red	60	74	33.3	0.59	0.68
	70	77	36.1	0.59	0.68
	80	79	38.4	0.59	0.68
	90	80	40.9	0.62	0.71
	100	82	42.8	0.61	0.71
43 Dk. Brown	60	77	38.1	0.62	0.71
	70	79	40.9	0.63	0.73
	80	82	43.9	0.63	0.73
	90	83	46.5	0.65	0.75
	100	84	48.5	0.66	0.76
48 Dk. Green	70	82	46.3	0.66	0.77
	80	86	49.6	0.65	0.75
	90	89	52.5	0.64	0.74
	100	90	54.8	0.65	0.75
	53 Dk. Blue*	70	85	50.5	0.67
80		88	53.5	0.66	0.77
90		90	57.4	0.68	0.79
100		92	59.5	0.68	0.78
63 Black		70	90	60.6	0.72
	80	92	63.2	0.72	0.83
	90	94	65.9	0.72	0.83
	100	96	69.4	0.72	0.84
	73 Orange NEW	80	95	72.1	0.77
90		97	75.9	0.78	0.90
100		99	79.5	0.78	0.90
110		101	83.0	0.78	0.90

* Factory-installed nozzle

** Preliminary performance data

Note: All ADV precipitation rates are calculated for 180-degree operation. For the precipitation rate for a 360-degree sprinkler, divide by 2. Precipitation rates for the 36V model are calculated at 360 degrees.



RESETTING THE STANDARD. Hunter sprays have been an industry benchmark for years, a lofty goal that has been reimaged over and over. From the conservation-minded MP Rotator to the multi-talented family of Pro-Sprays, Hunter's line of sprays doesn't know where to stop.

SPRAYS

COMPARISON CHART

	PS ULTRA	PRO-SPRAY®	PRS30*	PRS40†
APPLICATIONS				
Turfgrass	•	•	•	•
Turfgrass: Tall mowing height	•	•	•	•
Ground cover	•	•	•	•
Shrubs: Sprinklers on risers	•	•	•	•
Shrubs: Tall pop-up sprinklers		•	•	•
Residential	•	•	•	•
Commercial		•	•	•
High traffic areas		•	•	•
Reclaimed water		•	•	•
Field-installed check valve option	•	•	•	•
Factory-installed check valve option		•	•	•
Pressure regulation			•	•

* Formerly Institutional Spray

† Formerly MPR40

ADVANCED FEATURES

CO-MOLDED WIPER SEAL

This pressure-activated, multi-function wiper seal was designed to reduce flow-by. The zero flush seal operates at low pressures and allows more sprinkler heads on the same zone. The wiper seal's design protects the riser when operating, and keeps debris out of the seal when retracted, reducing riser stick-ups.



BODY CAP WON'T LEAK UNDER HIGH PRESSURE

The Pro-Spray line incorporates a heavy-duty ribbed body and durable cap engineered to withstand the harshest environments, including the rigors of foot traffic and the abuses of heavy machinery. In addition, a multi-thread buttress design provides superior strength in cap-to-body gripping capacity helping the head to withstand high inlet surge pressures.



Competitor

Pro-Spray

HEAVY-DUTY SPRING

The strongest retraction spring for positive retraction under any conditions.



PRESSURE REGULATED TO 30/40 PSI

Hunter's pressure regulated pop-up sprays are calibrated for the needs of any installation. The PRS30 with the brown cap optimizes performance of your traditional sprays at 30 PSI. The gray-capped PRS40 is designed for the efficient MP Rotator and is the only 40 PSI regulated pop-up on the market today.



ALL SPRAY BODIES AND NOZZLES are put to the test at Hunter's state-of-the-art facility so they are ready to take on any obstacle in the field.

Hunter®

PS ULTRA

APPLICATION

Residential

MODELS

2", 4", 6"

PS ULTRA IS THE SLIM SPRAY WITH ALL THE FEATURES FOR ANY INSTALLATION.

FEATURES

- Application: Residential
- Models: 2", 4", 6"
- Nozzle choices: 5
- Flow rate: 0.2 to 5.6 GPM
- Nozzle choices: 10A, 12A, 15A, 17A, 5' x 30' side strip (side strip pattern available on 2" and 4" models only)
- Warranty period: 2 years

ADVANCED PS ULTRA FEATURES

- Preinstalled Pro Adjustable nozzle
- Enhanced cap for more durability, easier handling, and extended riser seal life
- 2" and 4" models can retro-fit into older style PS sprays
- Two-piece ratchet
- Male threaded riser to accept all female nozzles
- Available with flush plug (large filter screen not included)
- Extra large filter screen

ADVANCED PRO ADJUSTABLE NOZZLE FEATURES

- Crisp edges result in well defined pattern
- Easy grip top for simple adjustments
- Large water droplets that can handle light winds
- Even distribution results in beautiful pattern
- Matched precipitation rate throughout nozzles

OPERATING SPECIFICATIONS

Flow rate: 0.2 to 5.6 GPM
 Radius: 9' to 19'
 Recommended pressure range: 20 to 70 PSI
 Precipitation rates: 1.6 to 1.9 in/hr approx.

USER INSTALLED OPTIONS

Drain check valve: 4" and 6" models (up to 7' of elevation; P/N 462237)
 Large basket filter screen (replacement; P/N 162900)

FACTORY INSTALLED OPTIONS

Nozzles: 10A, 12A, 15A, 17A, 5' x 30' side strip
 Flush plug (large basket filter screen not included)



SPECIFICATIONBUILDER

www.hunterindustries.com/PSULTRA

MODELS	RADIUS
PSU-02 = 2" pop-up	10A = 10' adjustable nozzle
PSU-04 = 4" pop-up	12A = 12' adjustable nozzle
PSU-06 = 6" pop-up	15A = 15' adjustable nozzle
	17A = 17' adjustable nozzle
	5SS = 5' X 30' side strip
	(2" and 4" only)

EXAMPLES

PSU-04 - 15A	4" pop-up, with a 15' adjustable nozzle
PSU-02 - 5SS	2" pop-up, with a 5' X 30' side strip
PSU-06 - 10A	6" pop-up, with a 10' adjustable nozzle
PSU-04	4" pop-up, with flush plug Large filter screen not included

PS ULTRA CHART

PS Ultra Standard Nozzles Performance Data

Arc	Pressure PSI	10 Foot Radius Adjustable from 0° to 360° Trajectory: 15° Color Code: Red				12 Foot Radius Adjustable from 0° to 360° Trajectory: 28° Color Code: Green				15 Foot Radius Adjustable from 0° to 360° Trajectory: 28° Color Code: Black				17 Foot Radius Adjustable from 0° to 360° Trajectory: 28° Color Code: Gray			
		Radius ft.	Flow GPM	Nozzle 10A Precip in/hr		Radius ft.	Flow GPM	Nozzle 12A Precip in/hr		Radius ft.	Flow GPM	Nozzle 15A Precip in/hr		Radius ft.	Flow GPM	Nozzle 17A Precip in/hr	
45° ▶	20	9	0.20	1.86	2.15	11	0.25	1.60	1.85	14	0.37	1.46	1.69	16	0.48	1.44	1.67
	25	10	0.22	1.71	1.97	12	0.28	1.52	1.76	15	0.42	1.44	1.66	17	0.54	1.45	1.67
	30	10	0.25	1.89	2.18	12	0.32	1.68	1.95	15	0.47	1.59	1.84	17	0.60	1.60	1.85
	35	11	0.27	1.70	1.96	13	0.34	1.56	1.80	16	0.51	1.52	1.76	18	0.65	1.55	1.79
90° ◐	20	9	0.39	1.86	2.15	11	0.50	1.60	1.85	14	0.74	1.46	1.69	16	0.96	1.44	1.67
	25	10	0.44	1.71	1.97	12	0.57	1.52	1.76	15	0.84	1.44	1.66	17	1.09	1.45	1.67
	30	10	0.49	1.89	2.18	12	0.63	1.68	1.95	15	0.93	1.59	1.84	17	1.20	1.60	1.85
	35	11	0.53	1.70	1.96	13	0.69	1.56	1.80	16	1.01	1.52	1.76	18	1.31	1.55	1.79
120° ◑	20	9	0.52	1.86	2.15	11	0.67	1.60	1.85	14	0.99	1.46	1.69	16	1.28	1.44	1.67
	25	10	0.59	1.71	1.97	12	0.76	1.52	1.76	15	1.12	1.44	1.66	17	1.45	1.45	1.67
	30	10	0.65	1.89	2.18	12	0.84	1.68	1.95	15	1.24	1.59	1.84	17	1.60	1.60	1.85
	35	11	0.71	1.70	1.96	13	0.91	1.56	1.80	16	1.35	1.52	1.76	18	1.74	1.55	1.79
180° ◒	20	9	0.78	1.86	2.15	11	1.01	1.60	1.85	14	1.49	1.46	1.69	16	1.92	1.44	1.67
	25	10	0.89	1.71	1.97	12	1.14	1.52	1.76	15	1.68	1.44	1.66	17	2.17	1.45	1.67
	30	10	0.98	1.89	2.18	12	1.26	1.68	1.95	15	1.86	1.59	1.84	17	2.40	1.60	1.85
	35	11	1.07	1.70	1.96	13	1.37	1.56	1.80	16	2.02	1.52	1.76	18	2.61	1.55	1.79
240° ◓	20	9	1.05	1.86	2.15	11	1.34	1.60	1.85	14	1.98	1.46	1.69	16	2.56	1.44	1.67
	25	10	1.18	1.71	1.97	12	1.52	1.52	1.76	15	2.24	1.44	1.66	17	2.89	1.45	1.67
	30	10	1.31	1.89	2.18	12	1.68	1.68	1.95	15	2.48	1.59	1.84	17	3.20	1.60	1.85
	35	11	1.42	1.70	1.96	13	1.83	1.56	1.80	16	2.70	1.52	1.76	18	3.48	1.55	1.79
270° ◔	20	9	1.18	1.86	2.15	11	1.51	1.60	1.85	14	2.23	1.46	1.69	16	2.88	1.44	1.67
	25	10	1.33	1.71	1.97	12	1.71	1.52	1.76	15	2.52	1.44	1.66	17	3.26	1.45	1.67
	30	10	1.47	1.89	2.18	12	1.89	1.68	1.95	15	2.79	1.59	1.84	17	3.60	1.60	1.85
	35	11	1.60	1.70	1.96	13	2.06	1.56	1.80	16	3.04	1.52	1.76	18	3.92	1.55	1.79
360° ●	20	9	1.57	1.86	2.15	11	2.02	1.60	1.85	14	2.98	1.46	1.69	16	3.84	1.44	1.67
	25	10	1.77	1.71	1.97	12	2.28	1.52	1.76	15	3.37	1.44	1.66	17	4.34	1.45	1.67
	30	10	1.96	1.89	2.18	12	2.52	1.68	1.95	15	3.72	1.59	1.84	17	4.80	1.60	1.85
	35	11	2.13	1.70	1.96	13	2.74	1.56	1.80	16	4.05	1.52	1.76	18	5.22	1.55	1.79
40	11	2.30	1.83	2.11	13	2.95	1.68	1.94	17	4.36	1.45	1.68	19	5.62	1.50	1.73	

Note: Optimum nozzle performance shown in bold.

Strip Pattern Nozzle Performance Data

Color Code: Blue

Nozzle Model	Pressure PSI	Width x Length (ft)	Flow GPM
SS-530	20	4 x 28	1.10
	25	5 x 30	1.20
Side Strip	30	5 x 30	1.30
Side Strip	35	5 x 30	1.40
	40	5 x 30	1.50

PRO-SPRAY®

APPLICATION

Residential/Commercial

MODELS

Shrub, 2", 3", 4", 6", 12"

RESIDENTIAL OR COMMERCIAL, THIS VERSATILE SPRINKLER IS THE CONTRACTOR'S CHOICE.

FEATURES

- Application: Residential/commercial
- Models: Shrub, 2", 3", 4", 6", 12"
- No side inlet (NSI) version available in 6" and 12"
- Warranty period: 5 years

ADVANCED FEATURES

- Co-molded wiper seal with UV resistant material
- Body cap won't leak under high pressure
- Drain check valve (optional)
- = Detailed description on pages 32 and 33
- Heavy-duty retraction spring
- Innovative directional flush plug design
- Reclaimed purple body cap (optional)
- Compatible with all female threaded nozzles

OPERATING SPECIFICATIONS

Recommended pressure range: 15 to 70 PSI

FACTORY INSTALLED OPTIONS

Drain check valve (up to 10' of elevation)
Reclaimed water ID cap

USER INSTALLED OPTIONS

Drain check valve (up to 10' of elevation; P/N 437400)
Reclaimed water ID cap (P/N 458520)
Snap-on reclaimed cover (P/N PROSRCCAP)



WORKS BEST WITH

MP ROTATOR

PRO-SPRAY FIXED ARC NOZZLES

PRO ADJUSTABLE NOZZLES

SPECIFICATIONBUILDER

www.hunterindustries.com/PROSPRAY

STANDARD MODELS	OPTIONS
PROS-00 = Shrub adapter	(blank) = No option
PROS-02 = 2" pop-up	CV = Factory-installed drain check valve (pop-up models only)
PROS-03 = 3" pop-up	CV-R = Factory-installed reclaimed body cap (shrub molded in purple)
PROS-04 = 4" pop-up	
PROS-06 = 6" pop-up	
PROS-06-NSI = 6" pop-up with no side inlet	6" and 12" models ordered as CV will come as no side inlet
PROS-12 = 12" pop-up	
PROS-12-NSI = 12" pop-up with no side inlet	

EXAMPLES

PROS-04 - 10A	4" pop-up, and 10' adjustable nozzle
PROS-06 - CV - 12H	6" pop-up, drain check valve, and 12' half circle nozzle
PROS-12 - CV-R - RCS	12" pop-up, drain check valve, reclaimed body cap, and right corner strip

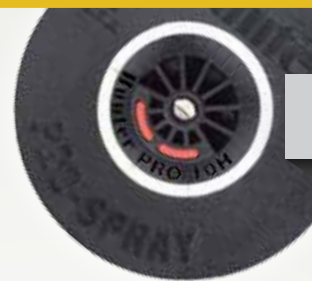

PROS-00:
Inlet size: 1/2" Female NPT



PROS-02: Overall height: 4"
Exposed diameter: 2 1/4"
Inlet size: 1/2" Female NPT



PROS-03: Overall height: 5"
Exposed diameter: 2 1/4"
Inlet size: 1/2" Female NPT



PROS-04: Overall height: 5 1/2"
Exposed diameter: 2 1/4"
Inlet size: 1/2" Female NPT



PROS-06: Overall height: 8 3/4"
PROS-06-NSI (right):
Exposed diameter: 2 1/4"
Inlet size: 1/2" Female NPT



PROS-12: Overall height: 16 1/8"
PROS-12-NSI (right)
Exposed diameter: 2 1/4"
Inlet size: 1/2" Female NPT

SPRAYS

PRS30

APPLICATION

Residential/Commercial

MODELS

Shrub, 4", 6", 12"

KEEP WATER PRESSURE AT A TRUE 30 PSI FOR COMMERCIAL SITES TO REDUCE WASTE AND MAXIMIZE PERFORMANCE.

FEATURES

- Application: Residential/commercial
- Models: Shrub, 4", 6", 12"
- No side inlet (NSI) version available in 6" and 12"
- Warranty period: 5 years

ADVANCED FEATURES

- Identification cap is brown for easy field ID
- Pressure regulated to 30 PSI
- Co-molded wiper seal with UV resistant material
- Body cap won't leak under high pressure
- = Detailed description on pages 32 and 33
- Drain check valve (optional)
- Heavy-duty retraction spring
- Innovative directional flush plug design
- Reclaimed purple body cap (optional)
- Compatible with all female threaded nozzles

OPERATING SPECIFICATIONS

Recommended pressure range: 15 to 100 PSI

FACTORY INSTALLED OPTIONS

Drain check valve (up to 14' of elevation)
Reclaimed water ID cap

USER INSTALLED OPTIONS

Vandal-proof cap (P/N PROS-PRS30-VPC)
Drain check valve (up to 14' of elevation; P/N 457400)
Reclaimed water ID cap (P/N 458530)
Snap-on reclaimed cover (P/N PROSRCCAP)

PRS30 formerly Institutional Spray

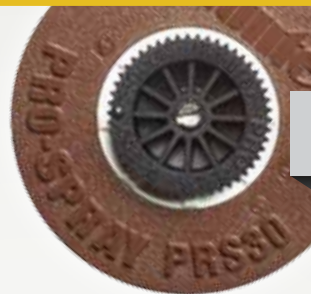

PROS-00-PRS-30:
Inlet size: 1/2" Female NPT



PROS-04-PRS30: Overall height: 5 7/8"
Exposed diameter: 2 1/4"
Inlet size: 1/2" Female NPT

PROS-06-PRS30: Overall height: 8 3/4"
PROS-06-PRS30-NSI (right)
Exposed diameter: 2 1/4"
Inlet size: 1/2" Female NPT



PROS-12-PRS30: Overall height: 16 1/8"
PROS-12-NSI-PRS30 (right)
Exposed diameter: 2 1/4"
Inlet size: 1/2" Female NPT



WORKS BEST WITH

PRO-SPRAY FIXED ARC NOZZLES

PRO ADJUSTABLE NOZZLES

SPECIFICATIONBUILDER

www.hunterindustries.com/PRS30

PRS30 MODELS (formerly Institutional Spray)	OPTIONS
PROS-00-PRS30 = 30 PSI regulated shrub adapter	(blank) = No option
PROS-04-PRS30 = 30 PSI regulated 4" pop-up	CV = Factory-installed drain check valve (pop-up models only)
PROS-06-PRS30 = 30 PSI regulated 6" pop-up	CV-R = Factory-installed drain check valve and reclaimed body cap (shrub molded in purple)
PROS-06-NSI-PRS30 = 30 PSI regulated 6" pop-up with no side inlet	
PROS-12-PRS30 = 30 PSI regulated 12" pop-up	6" and 12" models ordered as CV will come as no side inlet
PROS-12-NSI-PRS30 = 30 PSI regulated 12" pop-up with no side inlet	

EXAMPLES

PROS-04-PRS30	4" pop-up regulated at 30 PSI
PROS-06-PRS30 - CV - 12H	6" pop-up regulated at 30 PSI, drain check valve, and 12' half circle nozzle
PROS-12-PRS30 - CV-R - 10A	12" pop-up regulated at 30 PSI, drain check valve, reclaimed body cap, and 10' adjustable nozzle



PRS40

APPLICATION

Residential/Commercial

MODELS

Shrub, 4", 6", 12"

PRS40 IS DESIGNED FOR OPTIMAL PERFORMANCE AT 40 PSI WHEN PAIRED WITH THE REVOLUTIONARY MP ROTATOR.

FEATURES

- Application: Residential/commercial
- Models: Shrub, 4", 6", 12"
- No side inlet (NSI) version available in 6" and 12"
- Warranty period: 5 years

ADVANCED FEATURES

- Identification cap is gray for easy field ID
- Pressure regulated to 40 PSI
- Co-molded wiper seal with UV resistant material
- Drain check valve (up to 14' of elevation)
- Body cap won't leak under high pressure
- • = Detailed description on pages 32 and 33

- Heavy-duty retraction spring
- Innovative directional flush plug design
- Reclaimed purple body cap (optional)
- Compatible with all female threaded nozzles

OPERATING SPECIFICATIONS

Recommended pressure range: 15 to 100 PSI

FACTORY INSTALLED OPTIONS

Reclaimed water ID cap

USER INSTALLED OPTIONS

Reclaimed water ID cap (P/N 458530)

Snap-on reclaimed cover (P/N PROSRCCAP)

PRS40 formerly MPR40



PRESSURE
REGULATED AT
40 PSI



PROS-00-PRS40:
Inlet size: ½" Female NPT



PROS-04-PRS40:
Overall height: 5 7/8"
Exposed diameter: 2 1/4"
Inlet size: ½" Female NPT



PROS-06-PRS40-CV: Overall height: 8 3/4"
Exposed diameter: 2 1/4"
Inlet size: ½" Female NPT



PROS-12-PRS40-CV:
Overall height: 16 1/8"
Exposed diameter: 2 1/4"
Inlet size: ½" Female NPT

DESIGNED SPECIFICALLY FOR

MP ROTATOR

SPECIFICATIONBUILDER

www.hunterindustries.com/PRS40

PRS40 MODELS (formerly MPR40)	OPTIONS
PROS-00-PRS40 = 40 PSI regulated shrub adapter	(blank) = No option
PROS-04-PRS40-CV = 40 PSI regulated 4" pop-up	R = Factory-installed reclaimed body cap (shrub molded in purple)
PROS-06-PRS40-CV = 40 PSI regulated 6" pop-up	6" and 12" models will come as no side inlet
PROS-12-PRS40-CV = 40 PSI regulated 12" pop-up	

EXAMPLES

PROS-04-PRS40-CV	4" pop-up regulated at 40 PSI, and drain check valve
PROS-06-PRS40-CV	6" pop-up regulated at 40 PSI, and drain check valve
PROS-12-PRS40-CV - R	12" pop-up regulated at 40 PSI, drain check valve, and reclaimed body cap

NOZZLES

ANGLING FOR PERFECTION? Hunter nozzles leave site constraints behind. From narrow strips to curving hillsides, any installation will benefit from optimum distribution designed to exacting standards.

PRO ADJUSTABLE NOZZLES

PRO ADJUSTABLE NOZZLES ARE THE ALL-IN-ONE CHOICE FOR OPTIMAL COVERAGE.

FEATURES

- Crisp, well-defined edges
- Matched precipitation rate of 8' to 17'
- Easy grip top for simple adjustment
- Designed with large water droplets to withstand light winds
- Even distribution results in beautiful pattern
- New 4' and 6' Pro Adjustable Nozzles provide additional flexibility
- Color-coded for easy field identification
- Adjustable from 0° to 360°

OPERATING SPECIFICATIONS

Recommended operating pressure: 30 PSI

Specify the new Pro-Spray® PRS30 pop-up for accurate pressure regulation of 30 PSI

Pro Adjustable Nozzles Performance Data

Arc	Pressure PSI	4 Foot Radius Adjustable: 0° - 360° Trajectory: 0° Color Code: Lt. Green				6 Foot Radius Adjustable: 0° - 360° Trajectory: 0° Color Code: Lt. Blue			
		Radius ft.	Flow GPM	Precip in/hr		Radius ft.	Flow GPM	Precip in/hr	
45°	20	3	0.11	5.44	6.28	5	0.15	3.21	3.70
	25	3	0.13	6.02	6.95	5	0.15	3.21	3.70
	30	4	0.13	6.45	7.45	6	0.18	3.85	4.45
	35	4	0.14	6.74	7.78	6	0.18	3.85	4.45
90°	20	3	0.19	4.57	5.28	5	0.30	3.21	3.70
	25	3	0.20	4.81	5.56	5	0.31	3.32	3.83
	30	4	0.28	6.74	7.78	6	0.37	3.96	4.57
	35	4	0.24	5.78	6.67	6	0.38	4.06	4.69
120°	20	4	0.16	7.70	8.89	6	0.19	4.06	4.69
	25	3	0.19	4.57	5.28	5	0.30	3.21	3.70
	30	4	0.34	6.14	7.09	6	0.44	3.53	4.08
	35	4	0.34	6.14	7.09	6	0.46	3.69	4.26
180°	20	4	0.25	5.90	6.81	6	0.40	4.28	4.94
	25	3	0.28	5.05	5.84	5	0.37	2.97	3.43
	30	4	0.45	5.41	6.25	6	0.60	3.21	3.70
	35	4	0.46	5.53	6.39	6	0.64	3.42	3.95
240°	20	4	0.48	5.78	6.67	6	0.68	3.64	4.20
	25	3	0.58	5.23	6.04	5	0.73	2.93	0.85
	30	4	0.68	6.13	7.08	6	0.88	3.53	1.02
	35	4	0.74	6.68	7.71	6	0.92	3.69	1.07
270°	20	4	0.80	7.22	8.34	6	1.02	4.09	1.18
	25	3	0.59	4.73	5.46	5	0.88	3.14	3.62
	30	4	0.73	5.86	6.76	6	1.10	3.92	4.53
	35	4	0.76	6.10	7.04	6	1.15	4.10	4.73
360°	20	4	0.80	6.42	7.41	6	1.20	4.28	4.94
	25	3	0.66	3.97	4.58	5	1.05	2.81	3.24
	30	4	0.80	4.81	5.56	6	1.26	3.37	3.89
	35	4	0.86	5.17	5.97	6	1.30	3.48	4.01
	40	4	0.90	5.41	6.25	6	1.40	3.74	4.32

Note: The Pro-Spray PRS30's built-in pressure regulator controls output to a maximum of 30 PSI. Optimum nozzle performance shown in bold.



4A Nozzle
Radius: 4'

6A Nozzle
Radius: 6'

8A Nozzle
Radius: 8'

10A Nozzle
Radius: 10'

12A Nozzle
Radius: 12'

15A Nozzle
Radius: 15'

17A Nozzle
Radius: 17'

PRO ADJUSTABLE NOZZLES CHART

Pro Adjustable Nozzles Performance Data

Arc	Pressure PSI	8 Foot Radius Adjustable: 0° - 360° Trajectory: 0° Color Code: Brown				10 Foot Radius Adjustable: 0° - 360° Trajectory: 15° Color Code: Red			
		Radius ft.	Flow GPM	Precip in/hr		Radius ft.	Flow GPM	Precip in/hr	
45°	20	7	0.12	1.83	2.11	9	0.20	1.86	2.15
	25	8	0.13	1.58	1.83	10	0.22	1.71	1.97
	30	8	0.15	1.75	2.02	10	0.25	1.89	2.18
	35	9	0.16	1.51	1.74	11	0.27	1.70	1.96
90°	20	7	0.23	1.83	2.11	9	0.39	1.86	2.15
	25	8	0.26	1.58	1.83	10	0.44	1.71	1.97
	30	8	0.29	1.75	2.02	10	0.49	1.89	2.18
	35	9	0.32	1.51	1.74	11	0.53	1.70	1.96
120°	20	7	0.31	1.83	2.11	9	0.52	1.86	2.15
	25	8	0.35	1.58	1.83	10	0.59	1.71	1.97
	30	8	0.39	1.75	2.02	10	0.65	1.89	2.18
	35	9	0.42	1.51	1.74	11	0.71	1.70	1.96
180°	20	7	0.47	1.83	2.11	9	0.78	1.86	2.15
	25	8	0.53	1.58	1.83	10	0.89	1.71	1.97
	30	8	0.58	1.75	2.02	10	0.98	1.89	2.18
	35	9	0.63	1.51	1.74	11	1.07	1.70	1.96
240°	20	7	0.62	1.83	2.11	9	1.05	1.86	2.15
	25	8	0.70	1.58	1.83	10	1.18	1.71	1.97
	30	8	0.78	1.75	2.02	10	1.31	1.89	2.18
	35	9	0.84	1.51	1.74	11	1.42	1.70	1.96
270°	20	7	0.70	1.83	2.11	9	1.18	1.86	2.15
	25	8	0.79	1.58	1.83	10	1.33	1.71	1.97
	30	8	0.87	1.75	2.02	10	1.47	1.89	2.18
	35	9	0.95	1.51	1.74	11	1.60	1.70	1.96
360°	20	7	0.93	1.83	2.11	9	1.57	1.86	2.15
	25	8	1.05	1.58	1.83	10	1.77	1.71	1.97
	30	8	1.16	1.75	2.02	10	1.96	1.89	2.18
	35	9	1.27	1.51	1.74	11	2.13	1.70	1.96
40	9	1.36	1.62	1.87	11	2.30	1.83	2.11	



NOZZLES

Pro Adjustable Nozzles Performance Data

Arc	Pressure PSI	12 Foot Radius Adjustable: 0° - 360° Trajectory: 28° Color Code: Green				15 Foot Radius Adjustable: 0° - 360° Trajectory: 28° Color Code: Black				17 Foot Radius Adjustable: 0° - 360° Trajectory: 28° Color Code: Gray			
		Radius ft.	Flow GPM	Precip in/hr		Radius ft.	Flow GPM	Precip in/hr		Radius ft.	Flow GPM	Precip in/hr	
45°	20	11	0.25	1.60	1.85	14	0.37	1.46	1.69	16	0.48	1.44	1.67
	25	12	0.28	1.52	1.76	15	0.42	1.44	1.66	17	0.54	1.45	1.67
	30	12	0.32	1.68	1.95	15	0.47	1.59	1.84	17	0.60	1.60	1.85
	35	13	0.34	1.56	1.80	16	0.51	1.52	1.76	18	0.65	1.55	1.79
90°	20	11	0.50	1.60	1.85	14	0.74	1.46	1.69	16	0.96	1.44	1.67
	25	12	0.57	1.52	1.76	15	0.84	1.44	1.66	17	1.09	1.45	1.67
	30	12	0.63	1.68	1.95	15	0.93	1.59	1.84	17	1.20	1.60	1.85
	35	13	0.69	1.56	1.80	16	1.01	1.52	1.76	18	1.31	1.55	1.79
120°	20	11	0.74	1.68	1.94	17	1.09	1.45	1.68	19	1.41	1.50	1.73
	25	12	0.67	1.60	1.85	14	0.99	1.46	1.69	16	1.28	1.44	1.67
	30	12	0.84	1.68	1.95	15	1.24	1.59	1.84	17	1.60	1.60	1.85
	35	13	0.91	1.56	1.80	16	1.35	1.52	1.76	18	1.74	1.55	1.79
180°	20	11	0.98	1.68	1.94	17	1.45	1.45	1.68	19	1.87	1.50	1.73
	25	12	1.01	1.60	1.85	14	1.49	1.46	1.69	16	1.92	1.44	1.67
	30	12	1.14	1.52	1.76	15	1.68	1.44	1.66	17	2.17	1.45	1.67
	35	13	1.37	1.56	1.80	16	2.02	1.52	1.76	18	2.61	1.55	1.79
240°	20	11	1.48	1.68	1.94	17	2.18	1.45	1.68	19	2.81	1.50	1.73
	25	12	1.34	1.60	1.85	14	1.98	1.46	1.69	16	2.56	1.44	1.67
	30	12	1.52	1.52	1.76	15	2.24	1.44	1.66	17	2.89	1.45	1.67
	35	13	1.83	1.56	1.80	16	2.70	1.52	1.76	18	3.48	1.55	1.79
270°	20	11	1.97	1.68	1.94	17	2.91	1.45	1.68	19	3.75	1.50	1.73
	25	12	1.51	1.60	1.85	14	2.23	1.46	1.69	16	2.88	1.44	1.67
	30	12	1.89	1.68	1.95	15	2.79	1.59	1.84	17	3.60	1.60	1.85
	35	13	2.06	1.56	1.80	16	3.04	1.52	1.76	18	3.92	1.55	1.79
360°	20	11	2.21	1.68	1.94	17	3.27	1.45	1.68	19	4.22	1.50	1.73
	25	12	2.02	1.60	1.85	14	2.98	1.46	1.69	16	3.84	1.44	1.67
	30	12	2.28	1.52	1.76	15	3.37	1.44	1.66	17	4.34	1.45	1.67
	35	13	2.74	1.56	1.80	16	4.05	1.52	1.76	18	5.22	1.55	1.79
40	13	2.95	1.68	1.94	17	4.36	1.45	1.68	19	5.62	1.50	1.73	

Note: The Pro-Spray PRS30's built-in pressure regulator controls output to a maximum of 30 PSI. Optimum nozzle performance shown in bold.

PRO-SPRAY® FIXED ARC NOZZLES

GIVE YOUR SPRAYS SOME EDGE. WHEN PRECISION IS IMPERATIVE, PRO-SPRAY FIXED NOZZLES HAVE IT COVERED.

FEATURES

- Color-coded for easy field identification
- Optimum droplet size minimizes misting while maximizing uniformity
- New 1/3, 2/3, and 3/4 arc options for increased flexibility

OPERATING SPECIFICATIONS

Recommended operating pressure: 30 PSI

Specify the new Pro-Spray® PRS30 pop-up for accurate pressure regulation of 30 PSI



PRO-SPRAY® FIXED ARC NOZZLES CHART

Pro-Spray® Fixed Arc Nozzles Performance Data																				
		5 Foot Radius Fixed: 1/4, 1/2, Full Trajectory: 0° Color Code: Blue				8 Foot Radius Fixed: 1/4, 1/3, 1/2, Full Trajectory: 0° Color Code: Brown				10 Foot Radius Fixed: 1/4, 1/3, 1/2, Full Trajectory: 15° Color Code: Red										
Arc	Pattern	Pressure PSI	Radius		Flow		Precip in/hr		Radius		Flow		Precip in/hr		Radius		Flow		Precip in/hr	
			ft.	GPM	ft.	GPM	ft.	GPM	ft.	GPM	ft.	GPM	ft.	GPM	ft.	GPM	ft.	GPM	ft.	GPM
90°	Q	20	4	0.09	2.25	2.60	7	0.20	1.54	1.78	9	0.34	1.63	1.88						
		25	4	0.11	2.54	2.94	8	0.22	1.33	1.53	10	0.39	1.48	1.71						
		30	5	0.12	1.80	2.08	8	0.24	1.46	1.69	10	0.42	1.63	1.89						
		35	6	0.13	1.36	1.57	9	0.26	1.25	1.45	11	0.46	1.47	1.69						
		40	6	0.14	1.46	1.69	9	0.28	1.34	1.55	11	0.49	1.57	1.82						
120°	T	20	Use Hunter 4A or 6A Nozzle				7	0.26	1.54	1.78	9	0.46	1.63	1.88						
		25	Use Hunter 4A or 6A Nozzle				8	0.29	1.33	1.53	10	0.51	1.48	1.71						
		30	Use Hunter 4A or 6A Nozzle				8	0.32	1.46	1.69	10	0.57	1.63	1.89						
		35	Use Hunter 4A or 6A Nozzle				9	0.35	1.25	1.45	11	0.61	1.47	1.69						
		40	Use Hunter 4A or 6A Nozzle				9	0.38	1.34	1.55	11	0.66	1.57	1.82						
180°	H	20	4	0.19	2.25	2.60	7	0.38	1.49	1.72	9	0.70	1.67	1.92						
		25	4	0.21	2.54	2.94	8	0.43	1.28	1.48	10	0.79	1.53	1.76						
		30	5	0.23	1.80	2.08	8	0.47	1.41	1.63	10	0.88	1.69	1.95						
		35	6	0.25	1.36	1.57	9	0.51	1.21	1.39	11	0.95	1.52	1.75						
		40	6	0.27	1.46	1.69	9	0.54	1.29	1.49	11	1.03	1.63	1.89						
240°	TT	20	Use Hunter 4A or 6A Nozzle				Use Hunter 8A Nozzle				Use Hunter 10A Nozzle									
		25	Use Hunter 4A or 6A Nozzle				Use Hunter 8A Nozzle				Use Hunter 10A Nozzle									
		30	Use Hunter 4A or 6A Nozzle				Use Hunter 8A Nozzle				Use Hunter 10A Nozzle									
		35	Use Hunter 4A or 6A Nozzle				Use Hunter 8A Nozzle				Use Hunter 10A Nozzle									
		40	Use Hunter 4A or 6A Nozzle				Use Hunter 8A Nozzle				Use Hunter 10A Nozzle									
270°	TQ	20	Use Hunter 4A or 6A Nozzle				Use Hunter 8A Nozzle				Use Hunter 10A Nozzle									
		25	Use Hunter 4A or 6A Nozzle				Use Hunter 8A Nozzle				Use Hunter 10A Nozzle									
		30	Use Hunter 4A or 6A Nozzle				Use Hunter 8A Nozzle				Use Hunter 10A Nozzle									
		35	Use Hunter 4A or 6A Nozzle				Use Hunter 8A Nozzle				Use Hunter 10A Nozzle									
		40	Use Hunter 4A or 6A Nozzle				Use Hunter 8A Nozzle				Use Hunter 10A Nozzle									
360°	F	20	4	0.37	2.25	2.60	7	0.78	1.54	1.78	9	1.29	1.53	1.77						
		25	4	0.42	2.54	2.94	8	0.88	1.33	1.53	10	1.45	1.39	1.61						
		30	5	0.47	1.80	2.08	8	0.97	1.46	1.69	10	1.59	1.53	1.76						
		35	6	0.51	1.36	1.57	9	1.05	1.25	1.45	11	1.72	1.37	1.58						
		40	6	0.55	1.46	1.69	10	1.13	1.34	1.55	11	1.84	1.46	1.69						

Pro-Spray® Fixed Arc Nozzles Performance Data																				
		12 Foot Radius Fixed: 1/4, 1/3, 1/2, 2/3, 3/4, Full Trajectory: 28° Color Code: Green				15 Foot Radius Fixed: 1/4, 1/3, 1/2, 2/3, 3/4, Full Trajectory: 28° Color Code: Black				17 Foot Radius Fixed: 1/4, 1/2 Trajectory: 28° Color Code: Gray										
Arc	Pattern	Pressure PSI	Radius		Flow		Precip in/hr		Radius		Flow		Precip in/hr		Radius		Flow		Precip in/hr	
			ft.	GPM	ft.	GPM	ft.	GPM	ft.	GPM	ft.	GPM	ft.	GPM	ft.	GPM	ft.	GPM	ft.	GPM
90°	Q	20	11	0.54	1.71	1.98	14	0.78	1.53	1.77	16	0.93	1.40	1.61						
		25	12	0.61	1.62	1.87	15	0.88	1.51	1.74	17	1.05	1.39	1.61						
		30	12	0.67	1.78	2.06	15	0.97	1.67	1.92	17	1.15	1.54	1.77						
		35	13	0.72	1.65	1.90	16	1.06	1.59	1.84	18	1.25	1.49	1.72						
		40	13	0.78	1.77	2.04	17	1.14	1.52	1.75	19	1.34	1.43	1.65						
120°	T	20	11	0.72	1.71	1.98	14	1.04	1.53	1.77	Use Hunter 17A Nozzle									
		25	12	0.81	1.62	1.87	15	1.17	1.51	1.74										
		30	12	0.89	1.78	2.06	15	1.30	1.67	1.92										
		35	13	0.97	1.65	1.90	16	1.41	1.59	1.84										
		40	13	1.04	1.77	2.04	17	1.52	1.52	1.75										
180°	H	20	11	1.05	1.67	1.93	14	1.51	1.48	1.71	16	1.91	1.43	1.66						
		25	12	1.18	1.58	1.83	15	1.69	1.45	1.67	17	2.15	1.43	1.65						
		30	12	1.30	1.74	2.01	15	1.86	1.59	1.84	17	2.37	1.58	1.82						
		35	13	1.42	1.61	1.86	16	2.02	1.52	1.75	18	2.57	1.53	1.76						
		40	13	1.52	1.73	2.00	17	2.16	1.44	1.66	19	2.76	1.47	1.70						
240°	TT	20	11	1.40	1.67	1.93	14	2.01	1.48	1.71	Use Hunter 17A Nozzle									
		25	12	1.58	1.58	1.83	15	2.26	1.45	1.67										
		30	12	1.74	1.74	2.01	15	2.48	1.59	1.84										
		35	13	1.89	1.61	1.86	16	2.69	1.52	1.75										
		40	13	2.03	1.73	2.00	17	2.88	1.44	1.66										
270°	TQ	20	11	1.61	1.67	1.93	14	2.34	1.48	1.71	Use Hunter 17A Nozzle									
		25	12	1.82	1.58	1.83	15	2.64	1.45	1.67										
		30	12	2.00	1.74	2.01	15	2.92	1.59	1.84										
		35	13	2.17	1.61	1.86	16	3.18	1.52	1.75										
		40	13	2.33	1.73	2.00	17	3.42	1.44	1.66										
360°	F	20	11	2.17	1.72	1.99	14	3.04	1.49	1.72	Use Hunter 17A Nozzle									
		25	12	2.45	1.63	1.89	15	3.41	1.46	1.69										
		30	12	2.70	1.80	2.08	15	3.75	1.61	1.85										
		35	13	2.93	1.67	1.93	16	4.07	1.53	1.76										
		40	13	3.15	1.80	2.07	17	4.36	1.45	1.68										

Note: Optimum nozzle performance shown in bold.

NOZZLES

STREAM NOZZLES



These adjustable arc models handle stream sprays with ease. They offer sprays that at 30 PSI can water as far as 8' or 16', making them a great choice for slopes, ground cover and shrubbery applications.

STREAM SPRAY NOZZLES





Model S-8A Stream Spray Nozzle Performance Data

Adjustable: 25° to 360° Color Code: Blue ●

Arc	Pressure PSI	Radius ft.	Flow GPM	Precip in/hr	
				■	▲
90° 	20	7	0.29	2.28	2.63
	25	8	0.32	1.93	2.22
	30	8	0.35	2.11	2.43
	35	8	0.38	2.29	2.64
	40	9	0.41	1.95	2.25
180° 	20	7	0.54	2.12	2.45
	25	8	0.57	1.71	1.98
	30	8	0.60	1.80	2.08
	35	8	0.63	1.89	2.19
	40	9	0.66	1.57	1.81
360° 	20	7	1.08	2.12	2.45
	25	8	1.11	1.67	1.93
	30	8	1.15	1.73	2.00
	35	8	1.18	1.77	2.05
	40	9	1.22	1.45	1.67

Model S-16A Stream Spray Nozzle Performance Data

Adjustable: 25° to 360° Color Code: Blue ●

Arc	Pressure PSI	Radius ft.	Flow GPM	Precip in/hr	
				■	▲
90° 	20	15	0.40	0.68	0.79
	25	16	0.46	0.69	0.80
	30	16	0.50	0.75	0.87
	35	17	0.54	0.72	0.83
	40	18	0.57	0.68	0.78
180° 	20	15	0.67	0.57	0.66
	25	16	0.80	0.60	0.69
	30	16	0.88	0.66	0.76
	35	17	0.97	0.65	0.75
	40	18	1.04	0.62	0.71
360° 	20	15	1.19	0.51	0.59
	25	16	1.46	0.55	0.63
	30	16	1.66	0.62	0.72
	35	17	1.82	0.61	0.70
	40	18	1.99	0.59	0.68







STRIP PATTERN NOZZLES

Dealing with narrow planting areas? Narrow site constraints are no big deal when you have great nozzle options. Choose from center and end strips or corner and side strips. Either way, you'll enjoy optimum distribution from nozzles designed to exacting standards.



Strip Pattern Nozzle Performance Data

Color Code: Blue ●

Nozzle Model	Pressure PSI	Width x Length	Flow GPM
LCS-515  Left-Corner Strip	20	4 x 14	0.55
	25	5 x 15	0.60
	30	5 x 15	0.65
	35	5 x 15	0.70
	40	5 x 15	0.75
RCS-515  Right-Corner Strip	20	4 x 14	0.55
	25	5 x 15	0.60
	30	5 x 15	0.65
	35	5 x 15	0.70
	40	5 x 15	0.75
SS-530  Side Strip	20	4 x 28	1.10
	25	5 x 30	1.20
	30	5 x 30	1.30
	35	5 x 30	1.40
	40	5 x 30	1.50
ES-515  End Strip	20	4 x 14	0.55
	25	5 x 15	0.60
	30	5 x 15	0.65
	35	5 x 15	0.70
	40	5 x 15	0.75
CS-530  Center Strip	20	4 x 28	1.10
	25	5 x 30	1.20
	30	5 x 30	1.30
	35	5 x 30	1.40
	40	5 x 30	1.50
SS-918  Side Strip	20	8 x 17	1.45
	25	9 x 18	1.58
	30	9 x 18	1.72
	35	9 x 18	1.88
	40	9 x 18	2.08

NOZZLES/BUBBLERS

SHORT RADIUS NOZZLES

Small space solution in short order. When you need controlled irrigation for smaller spaces, these nozzles have small spaces covered. Available in 2', 4', and 6' radius versions.



Short Radius Nozzles Performance Data

Arc	Pressure PSI	Color Code: Light Brown					Color Code: Light Green					Color Code: Light Blue				
		Nozzle	Radius ft.	Flow GPM	Precip in/hr		Nozzle	Radius ft.	Flow GPM	Precip in/hr		Nozzle	Radius ft.	Flow GPM	Precip in/hr	
90°	20	2Q	2	0.09	8.66	10.00	4Q	4	0.20	4.81	5.56	6Q	6	0.47	5.03	5.80
	25		2	0.10	9.63	11.11		4	0.22	5.29	6.11		6	0.49	5.24	6.05
	30		2	0.11	10.59	12.23		4	0.22	5.29	6.11		6	0.51	5.45	6.30
	35		2	0.12	11.55	13.34		4	0.24	5.78	6.67		6	0.52	5.56	6.42
	40		2	0.14	13.48	15.56		4	0.24	5.78	6.67		6	0.52	5.56	6.42
180°	20	2H	2	0.12	5.78	6.67	4H	4	0.41	4.93	5.70	6H	6	0.95	5.08	5.87
	25		2	0.14	6.74	7.78		4	0.43	5.17	5.97		6	0.97	5.19	5.99
	30		2	0.16	7.70	8.89		4	0.44	5.29	6.11		6	0.98	5.24	6.05
	35		2	0.18	8.66	10.00		4	0.46	5.53	6.39		6	0.99	5.29	6.11
	40		2	0.18	8.66	10.00		4	0.46	5.53	6.39		6	1.00	5.35	6.17

PRESSURE-COMPENSATING BUBBLERS AND BUBBLER NOZZLES

Hunter bubblers keep the output of water constant regardless of pressure, for precise, easy application. Every plant, shrub, and tree receives the right amount of water with no excess runoff or waste.

MULTI-STREAM BUBBLER NOZZLES – MSBN

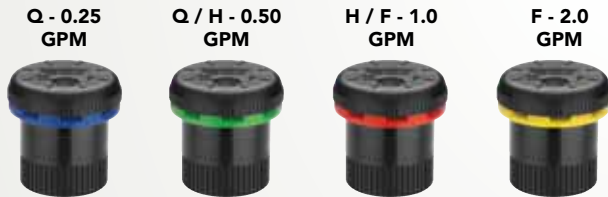

Multi-Stream Bubbler Performance Data

Arc	Model	Flow GPM	Radius ft.
☐	MSBN-25Q	0.25	1.0
	MSBN-50Q	0.50	1.5
☐	MSBN-50H	0.50	1.0
	MSBN-10H	1.00	1.5
☐	MSBN-10F	1.00	1.0
	MSBN-20F	2.00	1.5

Note: Typical spacing 2 to 4 ft. Flows shown for pressures between 15 and 70 PSI.

PCN BUBBLER NOZZLES



PCB / PCN & AFB Performance Data

Model	Flow GPM	Pattern Type
25	0.25	Trickle
50	0.50	Trickle
10	1.00	Umbrella
20	2.00	Umbrella

Note: Typical spacing 1 to 3 ft. Flows shown for pressures between 15 and 70 PSI.

PCB AND AFB BUBBLERS 1/2" INLET



DUAL-STREAM BUBBLER NOZZLES

5-CST-B



5-CST-B Bubbler Nozzle Performance Data

Pressure PSI	Radius ft.	Flow GPM
20	5	0.30
25	5	0.32
30	5	0.38
35	5	0.40
40	5	0.42



MP ROTATOR

MP ROTATORS

A REVELATION IN CONSERVATION.

Intelligent water use is no longer optional. Today, it is everyone's responsibility. Setting a new precedent in efficiency, Hunter's MP Rotator has started the revolution to change an industry, one spray, one installation, and one retrofit at a time.



MP ROTATOR®

MP ROTATOR

APPLICATION
Residential/Commercial

RADIUS
8' to 30'

www.hunterindustries.com/MP

MP ROTATORS SAVE MORE WITH 30% INCREASED EFFICIENCY OVER SPRAYS.

FEATURES

- True matched precipitation any arc or radius setting
- Radius can be reduced up to 25% on all models
- Color-coded for easy identification
- Double-pop feature keeps dirt and debris out of nozzle
- Removable filter screen prevents large objects from clogging nozzle
- Low precipitation rate
- Wind-resistant multi-stream technology
- Adjustable arc and radius offer timely and precise settings

ADVANCED FEATURES

- Ratchet mechanism prevents damage when attempting to reduce radius too far
- Models can only be adjusted while water is running

OPERATING SPECIFICATIONS

Recommended operating pressure: 40 PSI
Models can only be adjusted while water is running

OPTIONS

Pair with Pro-Spray PRS40 to achieve pressure regulation at the head of 40 PSI
Adding "HT" will specify male threaded nozzles



MP1000 8' to 15' radius



MP100090 90° to 210°
MP1000210 210° to 270°
MP1000360 360°

MP2000 13' to 21' radius



MP200090 90° to 210°
MP2000210 210° to 270°
MP2000360 360°

MP3000 22' to 30' radius



MP300090 90° to 210°
MP3000210 210° to 270°
MP3000360 360°

MP STRIPS



MPLCS515 Left Corner 5' x 15'
MPRCS515 Right Corner 5' x 15'



MPSS530 Side Strip 5' x 30'
MPCORNER * Corner 8' to 15'

* Applies additional water first 3' from the pop-up when head to head coverage is not available

SPECIFICATIONBUILDER

MODELS	OPTIONS
MP1000-90 = 8' to 15' radius, adjustable from 90° to 210° MP1000-210 = 8' to 15' radius, adjustable from 210° to 270° MP1000-360 = 8' to 15' radius, 360°	(blank) = No option HT = Male thread version
MP2000-90 = 13' to 21' radius, adjustable from 90° to 210° MP2000-210 = 13' to 21' radius, adjustable from 210° to 270° MP2000-360 = 13' to 21' radius, 360°	
MP3000-90 = 22' to 30' radius, adjustable from 90° to 210° MP3000-210 = 22' to 30' radius, adjustable from 210° to 270° MP3000-360 = 22' to 30' radius, 360°	
MPLCS515 = Left corner strip 5' x 15'	
MPRCS515 = Right corner strip 5' x 15'	
MPSS530 = Side strip 5' x 30'	
MPCORNER = 8' to 15' radius, adjustable from 45° to 105°	(MP Rotators are designed to operate in conjunction with a pop-up sprinkler or shrub adapter.)

EXAMPLE

MP1000-210	8' to 15' radius, adjustable from 210° to 270°
-------------------	--

MP ROTATOR CHARTS

MP Rotator Performance Data

MP1000 Radius: 8' to 15' Adjustable Arc and Full Circle Color Code: Maroon, Lt. Blue, or Olive							MP2000 Radius: 13' to 21' Adjustable Arc and Full Circle Color Code: Black, Green, or Red					MP3000 Radius: 22' to 30' Adjustable Arc and Full Circle Color Code: Blue, Yellow, or Gray							
Arc	Pressure PSI	Color	Radius ft.	Flow GPM	Flow GPH	Precip in/hr ▲	Color	Radius ft.	Flow GPM	Flow GPH	Precip in/hr ▲	Color	Radius ft.	Flow GPM	Flow GPH	Precip in/hr ▲			
90°	25	Maroon = 90° to 210°	-	-	-	-	Black = 90° to 210°	17	0.31	18.6	0.41	0.48	Blue = 90° to 210°	25	0.69	41.4	0.43	0.49	
	30		12	0.16	9.6	0.43		0.50	18	0.33	19.8	0.39		0.45	27	0.74	44.4	0.39	0.45
	35		13	0.18	10.8	0.40		0.46	19	0.37	22.2	0.39		0.46	28	0.80	48	0.39	0.45
	40		14	0.19	11.4	0.39		0.45	20	0.40	24	0.39		0.44	30	0.86	51.6	0.37	0.43
	45		14	0.20	12	0.39		0.45	21	0.42	25.2	0.37		0.42	30	0.91	54.6	0.39	0.45
	50		14	0.21	12.6	0.38		0.43	21	0.44	26.4	0.35		0.40	30	0.96	57.6	0.41	0.47
180°	25	Maroon = 90° to 210°	-	-	-	-	Black = 90° to 210°	16	0.58	34.8	0.44	0.50	Blue = 90° to 210°	25	1.44	86.4	0.44	0.51	
	30		12	0.32	19.2	0.43		0.50	17	0.63	37.8	0.42		0.49	27	1.58	94.8	0.42	0.48
	35		13	0.35	21	0.40		0.46	18	0.69	41.4	0.41		0.47	28	1.70	102	0.42	0.48
	40		14	0.37	22.2	0.39		0.45	19	0.74	44.4	0.39		0.45	30	1.82	109.2	0.39	0.45
	45		14	0.40	24	0.39		0.45	20	0.78	46.8	0.38		0.43	30	1.93	115.8	0.41	0.48
	50		14	0.41	24.6	0.38		0.43	21	0.83	49.8	0.36		0.41	30	2.04	122.4	0.44	0.50
210°	25	Lt. Blue = 210° to 270°	-	-	-	-	Green = 210° to 270°	16	0.68	40.8	0.44	0.50	Yellow = 210° to 270°	25	1.68	100.8	0.44	0.51	
	30		12	0.37	22.2	0.43		0.50	17	0.74	44.4	0.42		0.49	27	1.84	110.4	0.42	0.48
	35		13	0.41	24.6	0.40		0.46	18	0.80	48	0.41		0.47	28	1.99	119.4	0.42	0.48
	40		14	0.43	25.8	0.39		0.45	19	0.86	51.6	0.39		0.45	30	2.12	127.2	0.39	0.45
	45		14	0.46	27.6	0.39		0.45	20	0.92	55.2	0.38		0.43	30	2.25	135	0.41	0.48
	50		14	0.48	28.8	0.38		0.43	21	0.97	58.2	0.36		0.41	30	2.37	142.2	0.43	0.50
270°	25	Lt. Blue = 210° to 270°	-	-	-	-	Green = 210° to 270°	16	0.87	52.2	0.44	0.50	Yellow = 210° to 270°	25	2.19	131.4	0.45	0.52	
	30		12	0.48	29	0.43		0.50	17	0.95	57	0.42		0.49	27	2.37	142.2	0.42	0.48
	35		13	0.54	32	0.40		0.46	18	1.03	61.8	0.41		0.47	28	2.55	153	0.42	0.48
	40		14	0.57	34	0.39		0.45	19	1.10	66	0.39		0.45	30	2.73	163.8	0.39	0.45
	45		14	0.60	36	0.39		0.45	20	1.17	70.2	0.38		0.43	30	2.89	173.4	0.41	0.48
	50		14	0.63	38	0.38		0.43	21	1.23	73.8	0.36		0.41	30	3.06	183.6	0.44	0.50
360°	25	Olive = 360°	-	-	-	-	Red = 360°	16	1.16	69.6	0.44	0.50	Gray = 360°	25	2.88	172.8	0.44	0.51	
	30		12	0.65	39	0.43		0.50	17	1.27	76.2	0.42		0.49	27	3.15	189	0.42	0.48
	35		13	0.71	42.6	0.40		0.47	18	1.37	82.2	0.41		0.47	28	3.40	204	0.42	0.48
	40		14	0.75	45	0.39		0.46	19	1.47	88.2	0.39		0.45	30	3.64	218.4	0.39	0.45
	45		14	0.80	48	0.39		0.45	20	1.56	93.6	0.38		0.43	30	3.86	231.6	0.41	0.48
	50		14	0.84	50.4	0.38		0.44	21	1.64	98.4	0.36		0.41	30	4.07	244.2	0.44	0.50
55	15	0.87	52.2	0.37	0.43	21	1.70	102	0.37	0.43	30	4.27	256.2	0.46	0.53				



WORKS BEST WITH PRS40

See page 38.

MP ROTATORS

MP Rotator Performance Data

MPCorner Radius: 8' to 15' Adjustable Arc Color Code: Turquoise					
Arc	Pressure PSI	Color	Radius ft.	Flow GPM	Flow GPH
45°	25	Turquoise = 45° to 105°	-	-	-
	30		12	0.17	10.2
	35		13	0.18	10.8
	40		14	0.19	11.4
	45		14	0.21	12.6
	50		14	0.22	13.2
90°	25	Turquoise = 45° to 105°	11	0.31	18.6
	30		12	0.34	20.4
	35		13	0.36	21.6
	40		14	0.39	23.4
	45		14	0.41	24.6
	50		15	0.43	25.8
105°	25	Turquoise = 45° to 105°	11	0.36	21.6
	30		12	0.39	23.4
	35		13	0.42	25.2
	40		14	0.45	27
	45		14	0.48	28.8
	50		15	0.51	30.6
55	15	0.53	31.8		

MP Rotator Performance Data

MPLCS515 MPRCS515 MPSS530					
Nozzle Model	Pressure PSI	Color	Width x Length (ft.)	Flow GPM	Flow GPH
MP Left Strip	30	Ivory	4 x 14	0.19	11.4
	35		5 x 15	0.21	12.6
	40		5 x 15	0.22	13.2
	45		5 x 15	0.23	13.8
	50		6 x 16	0.25	15
	55		6 x 16	0.26	15.6
MP Right Strip	30	Copper	4 x 14	0.19	11.4
	35		5 x 15	0.21	12.6
	40		5 x 15	0.22	13.2
	45		5 x 15	0.23	13.8
	50		6 x 16	0.25	15
	55		6 x 16	0.26	15.6
MP Side Strip	30	Brown	4 x 28	0.38	22.8
	35		5 x 30	0.41	24.6
	40		5 x 30	0.44	26.4
	45		5 x 30	0.47	28.2
	50		6 x 32	0.49	29.4
	55		6 x 32	0.51	30.6

Note: Strip pattern radius can be adjusted by 25%. MP Rotator is designed to maintain matched precipitation after radius adjustment.



MP STICK

The MP Stick snaps on to 1" PVC of any length to easily adjust MP Rotators while standing up.



MP TOOL

Adjustments to MP Rotators are simply a snap with this handy tool.



THE NEXT LEVEL OF CONTROL. Where others can claim only reliability, Hunter valves use that as a starting point. Dependability is a given when innovation is the standard. Fully loaded with features to take on any size project, from a residential micro irrigation zone to a large turf rotor zone, these valves do more than deliver. They raise the bar.

VALVES

COMPARISON CHART

	SRV	PGV Jar-Top	PGV	ICV	ICV Filter Sentry™	IBV	IBV Filter Sentry™	Drip Control Zone Kit*
APPLICATIONS								
Potable water	•	•	•	•	•	•	•	•
Reclaimed water				•	•	•	•	•
Secondary water					•		•	•
Pressure regulation	•	•	•	•	•	•	•	•
Flow control	•	•	•	•	•	•	•	•
Angle option			•	•				
High pressure systems				•	•	•	•	
Low pressure system	•	•	•	•	•	•	•	•
Residential	•	•	•					•
Commercial			•	•	•	•	•	•

*See page 96

ADVANCED FEATURES

FLOW CONTROL

Maximize efficiency and prolong the life of a system by fine tuning flow and pressure for each zone.

SRV, PGV, PGV-JT, PGV-ASV, ICV, IBV



RECLAIMED WATER ID HANDLE

Violet tags and handles are an option for a clear, quick, and simple method of identifying the use of non-potable water.

SRV, PGV, PGV-JT, PGV-ASV, ICV, IBV (tag)



FILTER SENTRY™

The Filter Sentry scours the filter clean with a wiper that slides up and covers the entire screen when the valve opens. Even more, the wiper continues to scrub the filter's upper part during valve operation. The Filter Sentry can be added after the valve is installed as well.

ICV, IBV



ACCU-SYNC™ CAPABLE

Avoid sprinkler over-pressure conditions and experience significant water savings with Hunter's new Accu-Sync pressure regulator.

SRV, PGV, PGV-JT, PGV-ASV, ICV, IBV



ACCU-SYNC™

ACCU-SYNC BRINGS FIXED OR ADJUSTABLE PRESSURE REGULATION SIMPLY TO ANY ZONE

Accu-Sync is a simple pressure regulator designed for all of Hunter's control valves. The adjustable model enables the zone pressure to be set anywhere between 20 and 100 PSI, while fixed models remove the guesswork and can be installed throughout any system easily. No matter which model you choose, all zones stay in tune with Accu-Sync.

OPERATING SPECIFICATIONS

Regulation from 20 to 100 PSI (2 to 8 bar; 200 to 800 kPa)

Static pressure: 150 PSI (10 bar; 1000 kPa)

Required dynamic pressure differential: 15 PSI (1 bar; 100 kPa)

Works with AC and DC latching solenoids

Works with any Hunter valve

Accu-Sync Valve Recommended Flow Ranges

Valve	Flow GPM
SRV-100/101	5 to 30
PGV-100/101	5 to 30
PGV-151	20 to 120
PGV-201	40 to 150
ICV-101	5 to 40
ICV-151	20 to 150
ICV-201	40 to 200
ICV-301	150 to 300
IBV-101	5 to 40
IBV-151	20 to 150
IBV-201	40 to 200
IBV-301	150 to 300

The Accu-Sync shown installed on the ICV valve.



ADJUSTABLE

AS-ADJ:
Height with solenoid: 3¼"
Length: 4½"



FIXED

AS-20:
Height with solenoid: 3¼"
Length: 4⅜"

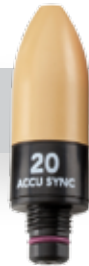

AS-30:
Height with solenoid: 3¼"
Length: 4⅜"



AS-40:
Height with solenoid: 3¼"
Length: 4⅜"



AS-50:
Height with solenoid: 3¼"
Length: 4⅜"



AS-70:
Height with solenoid: 3¼"
Length: 4⅜"



SRV

APPLICATION

Residential

SIZE

1"

FLOW RATE

1 to 30 GPM

WHERE DEPENDABILITY AND AFFORDABILITY ARE A QUESTION, SRV IS THE ANSWER.

FEATURES

- Application: Residential
- Size: 1"
- Double-beaded diaphragm seal design for superior leak-free performance
- DC latching solenoids enable Hunter's battery-powered controllers control of the valve
- Captive bonnet bolts provide hassle-free valve maintenance
- Low flow capability allows use of Hunter's micro-irrigation products
- Encapsulated 24 VAC solenoid with captive plunger for hassle-free service
- Temperature rating: 125° F
- Warranty period: 2 years

ADVANCED FEATURES

- Flow control (SRV101 only)
- Reclaimed water ID handle (SRV101 only)
- Accu-Sync™ capable
- = Detailed descriptions on pages 52 and 53

OPERATING SPECIFICATIONS

Flow rate: 1 to 30 GPM

Recommended pressure range: 20 to 150 PSI

FACTORY INSTALLED OPTIONS

Valve without solenoid

DC latching solenoid

USER INSTALLED OPTIONS

Solenoid conduit cover (P/N 464322)

DC latching solenoid (P/N 458200)

Accu-Sync pressure regulator

Reclaimed water ID (P/N 269205)

SRV Pressure Loss in PSI

GPM	1" Globe
1	1.1
5	1.9
10	1.9
15	1.6
20	3.3
25	5
30	6.1

Charts based on full-open flow control position

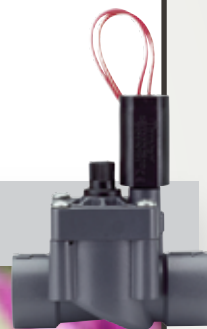

SRV-100G: 5" H x 4½" L x 2½" W

SRV-101G:
5" H x 4½" L x 2½" W

SPECIFICATIONBUILDER

www.hunterindustries.com/SRV

MODELS	INLET/OUTLET	OPTIONS FACTORY INSTALLED	OPTIONS USER INSTALLED
SRV-100G = 1" Globe valve, no flow control	(blank) = Female NPT S = Slip x slip B = BSP threads	DC = DC latching solenoid LS = Valve without solenoid	(blank) = No option R = Reclaimed water ID handle (except SRV-100G) DC = DC latching solenoid CC = Solenoid conduit cover AS-ADJ = Accu-Sync adjustable pressure regulator AS-20 = Accu-Sync 20 PSI pressure regulator AS-30 = Accu-Sync 30 PSI pressure regulator AS-40 = Accu-Sync 40 PSI pressure regulator AS-50 = Accu-Sync 50 PSI pressure regulator AS-70 = Accu-Sync 70 PSI pressure regulator
SRV-101G = 1" Globe valve, with flow control			

EXAMPLES

SRV-100G - R	1" Globe valve, no flow control, with reclaimed water ID handle
SRV-101G	1" Globe valve, with flow control
SRV-100G - DC	1" Globe valve, no flow control, with DC latching solenoid
SRV-101G - S - R	1" Globe valve, with flow control, slip x slip, and reclaimed water ID handle

PGV

APPLICATION

Residential/Light Commercial

SIZE

1", 1½", 2"

FLOW RATE

0.2 to 150 GPM

THESE PROFESSIONAL GRADE VALVES ARE READY FOR ALL SYSTEM SIZES.

FEATURES

- Application (PGV100): Residential
- Application (PGV101, 151, 201): Residential/light commercial
- Sizes: 1", 1½", 2"
- External and internal manual bleed allows quick and easy "at the valve" activation
- Durable bolted bonnet design for maximum strength
- Double-beaded diaphragm seal design for superior leak-free performance
- DC latching solenoids enable Hunter's battery-powered controllers
- Captive bonnet bolts provide hassle-free valve maintenance
- Low flow capability allows use of Hunter's micro-irrigation products
- Encapsulated 24 VAC solenoid with captive plunger for hassle-free service
- Temperature rating: 150° F
- Warranty period: 2 years

ADVANCED FEATURES

- Flow control (PGV101, 151, and 201 only)
- Accu-Sync™ capable
- = Detailed descriptions on pages 52 and 53

OPERATING SPECIFICATIONS (PGV100, 101)

Flow rate: 0.2 to 30 GPM

Recommended pressure range: 20 to 150 PSI

OPERATING SPECIFICATIONS (PGV151, 201)

Flow rate: 1½": 20 to 120 GPM;

2": 20 to 150 GPM

Recommended pressure range: 20 to 150 PSI

FACTORY INSTALLED OPTIONS

Valve without solenoid

DC latching solenoid

USER INSTALLED OPTIONS

Solenoid conduit cover (P/N 464322)

DC latching solenoid (P/N 458200)

Accu-Sync pressure regulator

Reclaimed water ID for PGV-101 models

(P/N 269205) and PGV-151/201 models

(P/N 607105)

PGV Pressure Loss in PSI

GPM	1"		1½"		2"	
	Globe	Angle	Globe	Angle	Globe	Angle
1	1.1	1				
5	1.9	1				
10	1.9	1				
15	1.6	1				
20	3.3	2	3	3	1	1
30	6.1	3	3	3	1	2
40			3	3	2	2
50			4	3.5	1	1
60			5	4	2	2
80			5.5	4.5	3	2
100			9	8	5	3
120			11.5	10.5	6	5
135					8	7
150					10	9

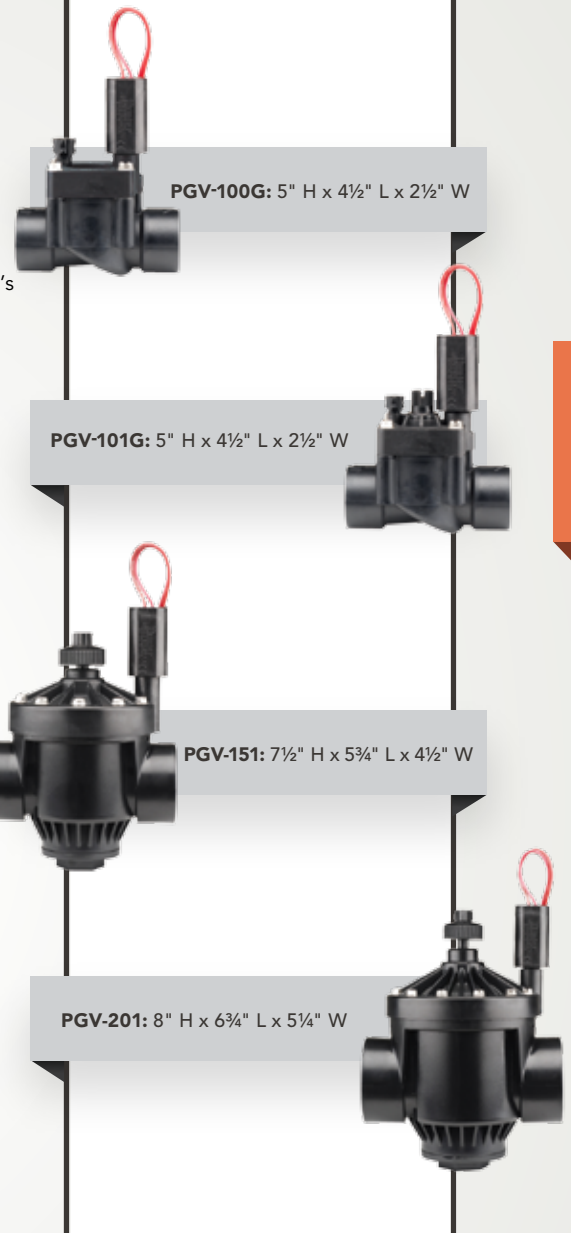

SPECIFICATIONBUILDER

www.hunterindustries.com/PGV

MODELS	INLET/OUTLET	OPTIONS FACTORY INSTALLED	OPTIONS USER INSTALLED
PGV-100G = 1" Globe valve, no flow control	(blank) = Female NPT S = Slip x slip (excludes PGV-151 and PGV-201) B = BSP threads	(blank) = No option DC = DC latching solenoid LS = Valve without solenoid	(blank) = No options R = Reclaimed water ID handle (except PGV-100G) CC = Solenoid conduit cover DC = DC latching solenoid AS-ADJ = Accu-Sync adjustable pressure regulator AS-20 = Accu-Sync 20 PSI pressure regulator AS-30 = Accu-Sync 30 PSI pressure regulator AS-40 = Accu-Sync 40 PSI pressure regulator AS-50 = Accu-Sync 50 PSI pressure regulator AS-70 = Accu-Sync 70 PSI pressure regulator
PGV-101G = 1" Globe valve, with flow control			
PGV-100A = 1" Angle valve, no flow control			
PGV-101A = 1" Angle valve, with flow control			
PGV-151 = 1½" Globe/angle valve, with flow control			
PGV-201 = 2" Globe/angle valve, with flow control	MB = Male thread x 1" barb MB125 = Male thread x 1¼" barb MM = Male x male (NPT)	(blank) = No option DC = DC latching solenoid LS = Valve without solenoid	(blank) = No options R = Reclaimed water ID handle (except PGV-100G) CC = Solenoid conduit cover DC = DC latching solenoid AS-ADJ = Accu-Sync adjustable pressure regulator AS-20 = Accu-Sync 20 PSI pressure regulator AS-30 = Accu-Sync 30 PSI pressure regulator AS-40 = Accu-Sync 40 PSI pressure regulator AS-50 = Accu-Sync 50 PSI pressure regulator AS-70 = Accu-Sync 70 PSI pressure regulator
PGV-100 = 1" Globe valve, no flow control			
PGV-101 = 1" Globe valve, with flow control			

EXAMPLES

PGV-101G - S - DC	1" Globe valve, with flow control, slip x slip, and DC latching solenoid
PGV-100 - MB - AS	1" Globe valve, no flow control, male thread x 1" barb, and Accu-Sync™ pressure regulator
PGV-151 - DC - R	1½" Globe/angle valve, with flow control, DC latching solenoid, and reclaimed water ID handle

PGV JAR-TOP

APPLICATION

Residential

SIZE

1"

FLOW RATE

0.2 to 30 GPM

THE JAR-TOP MAKES THIS GO-TO VALVE AN EASY CHOICE WITH SIMPLE SERVICEABILITY.

FEATURES

- Application: Residential
- Size: 1"
- External and internal manual bleed allows quick and easy "at the valve" activation
- Durable glass-filled nylon threaded bonnet ring allows easy access without tools
- Double-beaded diaphragm seal design for superior leak-free performance
- DC latching solenoids enable Hunter's battery-powered controllers
- Low flow capability allows use of Hunter's micro-irrigation products
- Encapsulated 24 VAC solenoid with captive plunger for hassle-free service
- Temperature rating: 150° F
- Warranty period: 2 years

ADVANCED FEATURES

- Flow control (PGV101 Jar-Top only)
- Reclaimed water ID handle (PGV101 Jar-Top only)
- Accu-Sync™ capable
- = Detailed descriptions on pages 52 and 53

OPERATING SPECIFICATIONS

Flow rate: 0.2 to 30 GPM
 Recommended pressure range: 20 to 150 PSI

FACTORY INSTALLED OPTIONS

Valve without solenoid
 DC latching solenoid

USER INSTALLED OPTIONS

Solenoid conduit cover (P/N 464322)
 DC latching solenoid (P/N 458200)
 Accu-Sync pressure regulator
 Reclaimed water ID (P/N 269205)

PGV Jar-Top Pressure Loss in PSI

GPM	1"
1	1.1
5	1.9
10	1.9
15	1.6
20	3.3
30	6.1

Charts based on full-open flow control position



PGV-100JT - G:
5½" H x 4½" L x 3¼" W

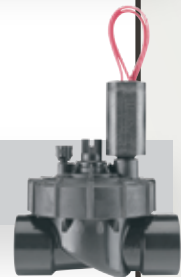

PGV-101JT - G:
5½" H x 4½" L x 3¼" W



SPECIFICATIONBUILDER

www.hunterindustries.com/PGVJARTOP

MODELS	INLET/OUTLET	OPTIONS FACTORY INSTALLED	OPTIONS USER INSTALLED
PGV-100JT = 1" Globe jar-top valve, no flow control	G = Female NPT GS = Slip x slip GB = BSP threads MM = Male x male (NPT) MMB = Male x male (BSP) MB = Male x 1" barb MB075 = Male x ¾" barb MB125 = Male x 1¼" barb	(blank) = No option LS = Less solenoid (only available on 101JT - G, 100JT - G, 101JT - GB, 100JT - GB) DC = DC latching solenoid	(blank) = No option R = Reclaimed water ID handle CC = Solenoid conduit cover DC = DC latching solenoid AS-ADJ = Accu-Sync adjustable pressure regulator AS-20 = Accu-Sync 20 PSI pressure regulator AS-30 = Accu-Sync 30 PSI pressure regulator AS-40 = Accu-Sync 40 PSI pressure regulator AS-50 = Accu-Sync 50 PSI pressure regulator AS-70 = Accu-Sync 70 PSI pressure regulator
PGV-101JT = 1" Globe jar-top valve, with flow control			

EXAMPLES

PGV-101JT - G	1" Globe jar-top valve, with flow control, and female NPT
PGV-101JT - GS - R	1" Globe jar-top valve, with flow control, slip x slip, and reclaimed water ID handle
PGV-101JT - G - R	1" Globe jar-top valve, with flow control, female NPT, and reclaimed water ID handle
PGV-100JT - MB075 - DC	1" Globe jar-top valve, no flow control, with male x ¾" barb, and DC latching solenoid

VALVES

PGV-ASV

APPLICATION

Residential

SIZES

¾", 1"

FLOW RATE

0.2 to 30 GPM

PGV-ASV PROVIDES SIMPLE AND TROUBLE-FREE OPERATION WITHOUT THE NEED FOR A SEPARATE BACKFLOW PREVENTER.

FEATURES

- Application: Residential
- Sizes: ¾", 1"
- External and internal manual bleed allows quick and easy "at the valve" activation
- Durable six-bolt bonnet design for maximum strength
- Removable anti-siphon cap for simple servicing
- Double-beaded diaphragm seal design for superior leak-free performance
- DC latching solenoids enable Hunter's battery-powered controllers
- Captive bonnet bolts provide hassle-free valve maintenance
- Low flow capability allows use of Hunter's micro irrigation products
- Encapsulated 24 VAC solenoid with captive plunger for hassle-free service
- Temperature rating: 150° F
- Warranty period: 2 years

ADVANCED FEATURES

- Flow control
- Reclaimed water ID handle
- Accu-Sync™ capable
- = Detailed descriptions on pages 52 and 53

OPERATING SPECIFICATIONS

Flow rate: 0.2 to 30 GPM

Recommended pressure range: 20 to 150 PSI

FACTORY INSTALLED OPTIONS

Valve without solenoid

USER INSTALLED OPTIONS

Solenoid conduit cover (P/N 464322)

DC latching solenoid (P/N 458200)

Accu-Sync™ pressure regulator

Reclaimed water ID (P/N 269205)

AVB Pressure Loss in PSI

GPM	1"
1	<1
5	<1
10	1.2
15	2.2
20	3.6
25	5.2
30	7

PGV-ASV Pressure Loss in PSI

GPM	¾"	1"
1	1	1
5	2	2
10	2	2
15	3	3
20	6	6
25		6
30		9

Charts based on full-open flow control position



PGV-075-ASV:
5½" H x 5¾" L x 2½" W



PGV-101-ASV:
5½" H x 6¼" L x 2½" W



AVB-100:
4½" H x 5¾" L x 3" W

VALVES

SPECIFICATIONBUILDER

www.hunterindustries.com/PGVASV

MODELS	INLET/OUTLET	OPTIONS FACTORY INSTALLED	OPTIONS USER INSTALLED
PGV-075 = ¾" Anti-siphon valves with flow control	ASV = Female NPT ASV-S = Slip x slip	LS = Valve without solenoid	(blank) = No option R = Reclaimed water ID handle DC = DC latching solenoid CC = Solenoid conduit cover AS-ADJ = Accu-Sync adjustable pressure regulator AS-20 = Accu-Sync 20 PSI pressure regulator AS-30 = Accu-Sync 30 PSI pressure regulator AS-40 = Accu-Sync 40 PSI pressure regulator AS-50 = Accu-Sync 50 PSI pressure regulator AS-70 = Accu-Sync 70 PSI pressure regulator
PGV-101 = 1" Anti-siphon valves with flow control			

EXAMPLES

PGV-075 - ASV	¾" Anti-siphon valves with flow control, and female NPT
PGV-101 - ASV-S - DC	1" Anti-siphon valves with flow control, slip x slip, and DC latching solenoid
PGV-101 - ASV - R	1" Anti-siphon valves with flow control, female NPT, and reclaimed water ID handle

MODEL

AVB-100 = 1" Atmospheric vacuum breaker/female NPT

AVB-100



APPLICATION: Commercial/Municipal
 SIZES: 1", 1½", 2", 3"
 FLOW RATE: 0.1 to 300 GPM

ICV IS ONE VALVE READY TO TAKE ON ANY COMMERCIAL HIGH-PRESSURE SYSTEM.

FEATURES

- Application: Commercial/municipal
- Sizes: 1", 1½", 2", 3"
- External and internal manual bleed allows quick and easy "at the valve" activation
- Glass-filled nylon construction resulting in the highest pressure rating
- Double-beaded diaphragm seal design for superior leak-free performance
- Fabric reinforced EPDM diaphragm and EPDM seat ensure superior performance in all conditions
- DC latching solenoids enable Hunter's battery-powered controllers
- Captive bonnet bolts provide hassle-free valve maintenance
- Low flow capability allows use Hunter's micro-irrigation products
- Encapsulated 24 VAC solenoid with captive plunger for hassle-free service
- Temperature rating: 150° F
- Warranty period: 5 years

ADVANCED FEATURES

- Flow control
- Filter Sentry™
- Reclaimed water ID handle
- Accu-Sync™ capable

OPERATING SPECS

1" Flow rate: 0.1 to 40 GPM
 1½" Flow rate: 20 to 135 GPM
 2" Flow rate: 40 to 150 GPM
 3" Flow rate: 150 to 300 GPM
 Recommended pressure range: 20 to 220 PSI

FACTORY INSTALLED OPTIONS

Valve without solenoid
 DC latching solenoid
 Filter Sentry

USER INSTALLED OPTIONS

Solenoid conduit cover (P/N 464322)
 DC latching solenoid (P/N 458200)
 Accu-Sync pressure regulator
 Reclaimed water ID for ICV101, 151, and 201 (P/N 561205) and 301 (P/N 515005)

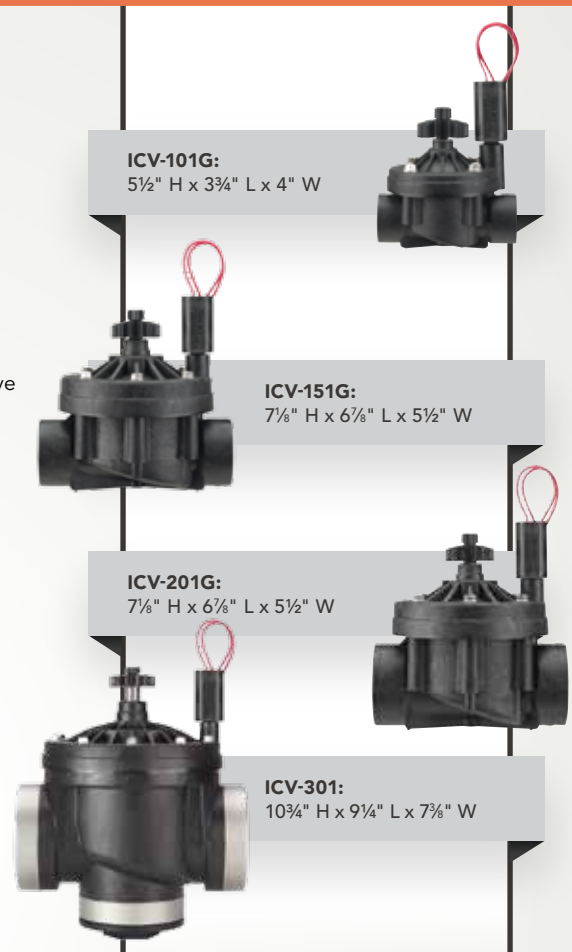

ICV Pressure Loss in PSI					ICV Pressure Loss in PSI					ICV Pressure Loss in PSI				
3"					3"					3"				
GPM	1"	1½"	2"	Globe Angle	GPM	1"	1½"	2"	Globe Angle	GPM	1"	1½"	2"	Globe Angle
0.1	2				40	7	1.7	0.8		150		16.2	9.8	2.5
0.5	2				50		2.2	1.2		175			13.3	3
1	2				60		3	1.7		200			17.7	4.1
5	2.5				75		3.9	2.4		225				5.3
10	3				90		5.5	3.2		250				6.7
15	3				100		7	4.2		275				8.3
20	3	1.5			120		10.9	6.5		300				10.1
30	4	1.5			135		12.7	7.9						8.5

Charts based on full-open flow control position

SPECIFICATIONBUILDER

www.hunterindustries.com/ICV

MODELS	INLET/OUTLET	OPTIONS FACTORY INSTALLED	OPTIONS USER INSTALLED
ICV-101G = 1" globe valve	(blank) = NPT threads B = BSP threads	(blank) = No option FS = Filter Sentry DC = DC latching solenoid LS = Valve without solenoid	(blank) = No option R = Reclaimed water ID tag CC = Solenoid conduit cover DC = DC latching solenoid AS-ADJ = Accu-Sync adjustable pressure regulator AS-20 = Accu-Sync 20 PSI pressure regulator AS-30 = Accu-Sync 30 PSI pressure regulator AS-40 = Accu-Sync 40 PSI pressure regulator AS-50 = Accu-Sync 50 PSI pressure regulator AS-70 = Accu-Sync 70 PSI pressure regulator
ICV-151G = 1½" globe valve			
ICV-201G = 2" globe valve			
ICV-301 = 3" globe/angle valve			

EXAMPLES

ICV-101G	1" globe valve, NPT threads
ICV-151G - FS - R	1½" globe valve, NPT threads, Filter Sentry, and reclaimed water ID tag

VALVES

IBV

APPLICATION
Commercial/MunicipalSIZES
1", 1½", 2", 3"FLOW RATE
0.1 to 300 GPM

THE HIGH-END IBV BRASS VALVE WAS DESIGNED FOR THE RIGORS OF A COMMERCIAL SITE.

FEATURES

- Application: Commercial/municipal
- Sizes: 1", 1½", 2", 3"
- External and internal manual bleed allows quick and easy "at the valve" activation
- Double-beaded diaphragm seal design for superior leak-free performance
- Fabric reinforced EPDM diaphragm and EPDM seat ensure superior performance in all conditions
- DC latching solenoids enable Hunter's battery-powered controllers
- Captive bonnet bolts providing hassle-free valve maintenance
- Low flow capability allows use of Hunter's micro irrigation products
- Encapsulated 24 VAC solenoid with captive plunger for hassle-free service
- Temperature rating: 150° F
- Warranty period: 5 years

ADVANCED FEATURES

- Flow control
- Filter Sentry™
- Accu-Sync™ capable
- = Detailed descriptions on pages 52 and 53

OPERATING SPECS

1" Flow rate: 0.1 to 40 GPM

1½" Flow rate: 20 to 135 GPM

2" Flow rate: 40 to 150 GPM

3" Flow rate: 150 to 300 GPM

Recommended pressure range: 20 to 220 PSI

FACTORY INSTALLED OPTIONS

Valve without solenoid

DC latching solenoid

Filter Sentry

USER INSTALLED OPTIONS

Solenoid conduit cover (P/N 464322)

DC latching solenoid (P/N 45800)

Accu-Sync pressure regulator

Reclaimed water ID (P/N 269205)

IBV Pressure Loss in PSI

GPM	1"	1½"	2"	3"
0.1	2			
0.5	2			
1	2			
5	2.5			
10	3			
15	3			
20	3	1.5		
30	4	1.5		
40	7	1.7	0.8	
50		2.2	1.2	
60		3	1.7	
75		3.9	2.4	
90		5.5	3.2	
100		7	4.2	
120		10.9	6.5	
135		12.7	7.9	
150		16.2	9.8	2.5
175			13.3	3
200			17.7	4.1
225				5.3
250				6.7
275				8.3
300				10.1

Charts based on full-open flow control position

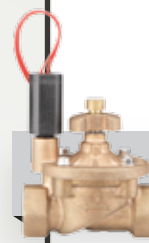

IBV-101G:
4½" H x 3¾" L x 5¼" W



IBV-151G:
6¼" H x 5¼" L x 6 ⅛" W

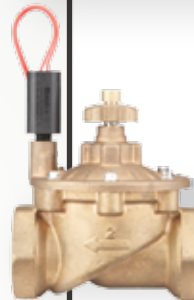

IBV-201G:
6 ⅞" H x 5¼" L x 6 ⅞" W

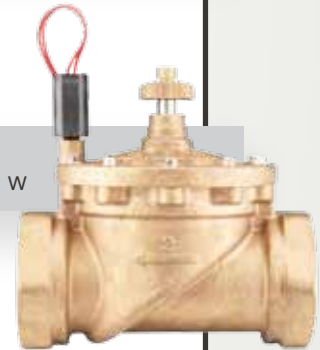

IBV-301G:
9 ⅞" H x 7¼" L x 9 ⅞" W

SPECIFICATION BUILDER

www.hunterindustries.com/IBV

MODELS	INLET/OUTLET	OPTIONS FACTORY INSTALLED	OPTIONS USER INSTALLED
IBV-101G = 1" globe valve	(blank) = NPT threads B = BSP threads	(blank) = No option FS = Filter Sentry DC = DC latching solenoid LS = Valve without solenoid	(blank) = No option R = Reclaimed water ID tag CC = Solenoid conduit cover DC = DC latching solenoid AS-ADJ = Accu-Sync adjustable pressure regulator AS-20 = Accu-Sync 20 PSI pressure regulator AS-30 = Accu-Sync 30 PSI pressure regulator AS-40 = Accu-Sync 40 PSI pressure regulator AS-50 = Accu-Sync 50 PSI pressure regulator AS-70 = Accu-Sync 70 PSI pressure regulator
IBV-151G = 1½" globe valve			
IBV-201G = 2" globe valve			
IBV-301G = 3" globe valve			

EXAMPLES

IBV-101G	1" globe valve
IBV-151G - FS - R	1½" globe valve, NPT threads, Filter Sentry, and reclaimed water ID tag

QUICK COUPLERS

APPLICATION
Commercial

QUICK COUPLERS WITH ULTRA STURDY RED BRASS AND STAINLESS STEEL CONSTRUCTION ADD VALUE TO ANY PROJECT.

FEATURES

- 100% Interchangeable with Rain Bird®, Toro®, and Buckner®
- Red brass and stainless steel construction
- TuffTop™ thermoplastic locking and non-locking covers
- WingThing™ stabilization and acme key connection
- Stainless steel lug on 1" and 1¼" keys
- Spring-loaded covers with stainless steel springs for positive closing and protection of valve's sealing components

See page 103 for replacement guide

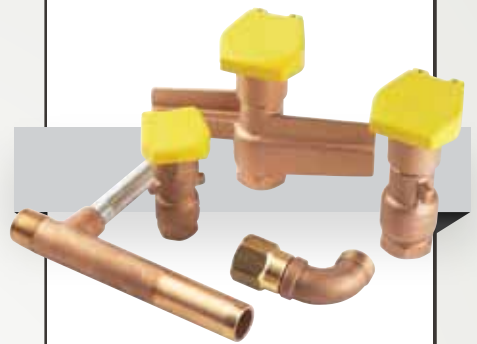

MODEL	INLET THREADS	SLOTS	BODY	COLOR *	LOCKING	KEY	SWIVELS
HQ-3RC	3/4" NPT	2	1 - Piece	Yellow	No	HK-33	HS-0
HQ-33DRC	3/4" NPT	2	2 - Piece	Yellow	No	HK-33	HS-0
HQ-33DLRC	3/4" NPT	2	2 - Piece	Yellow	Yes	HK-33	HS-0
HQ-44RC	1" NPT	1	2 - Piece	Yellow	No	HK-44	HS-1 or HS-2
HQ-44LRC	1" NPT	1	2 - Piece	Yellow	Yes	HK-44	HS-1 or HS-2
HQ-44RC-AW	1" NPT	Acme	2 - Piece Wing†	Yellow	No	HK-44A	HS-1 or HS-2
HQ-44LRC-AW	1" NPT	Acme	2 - Piece Wing†	Yellow	Yes	HK-44A	HS-1 or HS-2
HQ-5RC	1" NPT	2	1 - Piece	Yellow	No	HK-55	HS-1 or HS-2
HQ-5LRC	1" NPT	2	1 - Piece	Yellow	Yes	HK-55	HS-1 or HS-2
HQ-5RC-B	1" BSP	2	1 - Piece	Yellow	No	HK-55	HS-1-B or HS-2-B
HQ-5LRC-B	1" BSP	2	1 - Piece	Yellow	Yes	HK-55	HS-1-B or HS-2-B

* All locking cover models are available with purple covers for reclaimed water applications.

† Anti-rotation stabilization wings.

SPECIFICATIONBUILDER

www.hunterindustries.com/HQ

HQ - VALVE MODELS	COVER OPTIONS	ADDITIONAL OPTIONS
HQ3 = ¾" Inlet, 1-piece body, 2 slots	RC = Yellow rubber cover LRC = Yellow locking rubber cover (Not available for the HQ3 body)	(blank) = No option AW = Acme key with anti-rotation wings* BSP = BSP threads † R = Purple locking cover (reclaimed water ID) ‡
HQ5 = 1" Inlet, 1-piece body, 2 slots		
HQ33D = ¾" Inlet, 2-piece body, 2 slots		
HQ44 = 1" Inlet, 2-piece body, 1 slot or acme		

EXAMPLES

HQ3 - RC	HQ3 valve with rubber cover
HQ44 - LRC	HQ44 valve with locking rubber cover
HQ44 - LRC - R	HQ44 valve with locking rubber cover and reclaimed water ID
HQ44 - LRC - AW - R	HQ valve, locking rubber cover, acme key socket, anti-rotation wings and reclaimed ID
HQ5 - LRC - BSP	HQ5 valve with locking rubber cover and BSP body inlet threads

* only available in body HQ44

† only available in body HQ5

‡ only available LRC models



All locking models have an optional purple TuffTop™ cover for sites using reclaimed water.

HK - KEY MODELS	COMPATIBLE VALVE	COMPATIBLE SWIVEL
HK33 = ¾" valve, ¾" key inlet	HQ3, HQ33	HS0
HK44 = 1" valve, 1" key inlet	HQ44	HS1, HS2, HS1B, HS2B
HK44A = 1" valve, acme key inlet	HQ44AW	HS1, HS2, HS1B, HS2B
HK55 = 1" valve, 1¼" key inlet	HQ5	HS1, HS2, HS1B, HS2B

EXAMPLE

HK-44

HOSE SWIVELS	COMPATIBLE KEY
HS0 = ¾" inlet, ¾" hose outlet	HK33
HS1 = 1" inlet, ¾" hose outlet	HK44, HK44A, HK55
HS2 = 1" inlet, 1" hose outlet	HK44, HK44A, HK55
HS1B = 1" inlet, ¾" BSP outlet	HK44, HK44A, HK55
HS2B = 1" inlet, 1" BSP outlet	HK44, HK44A, HK55

EXAMPLE

HS-1

VALVES

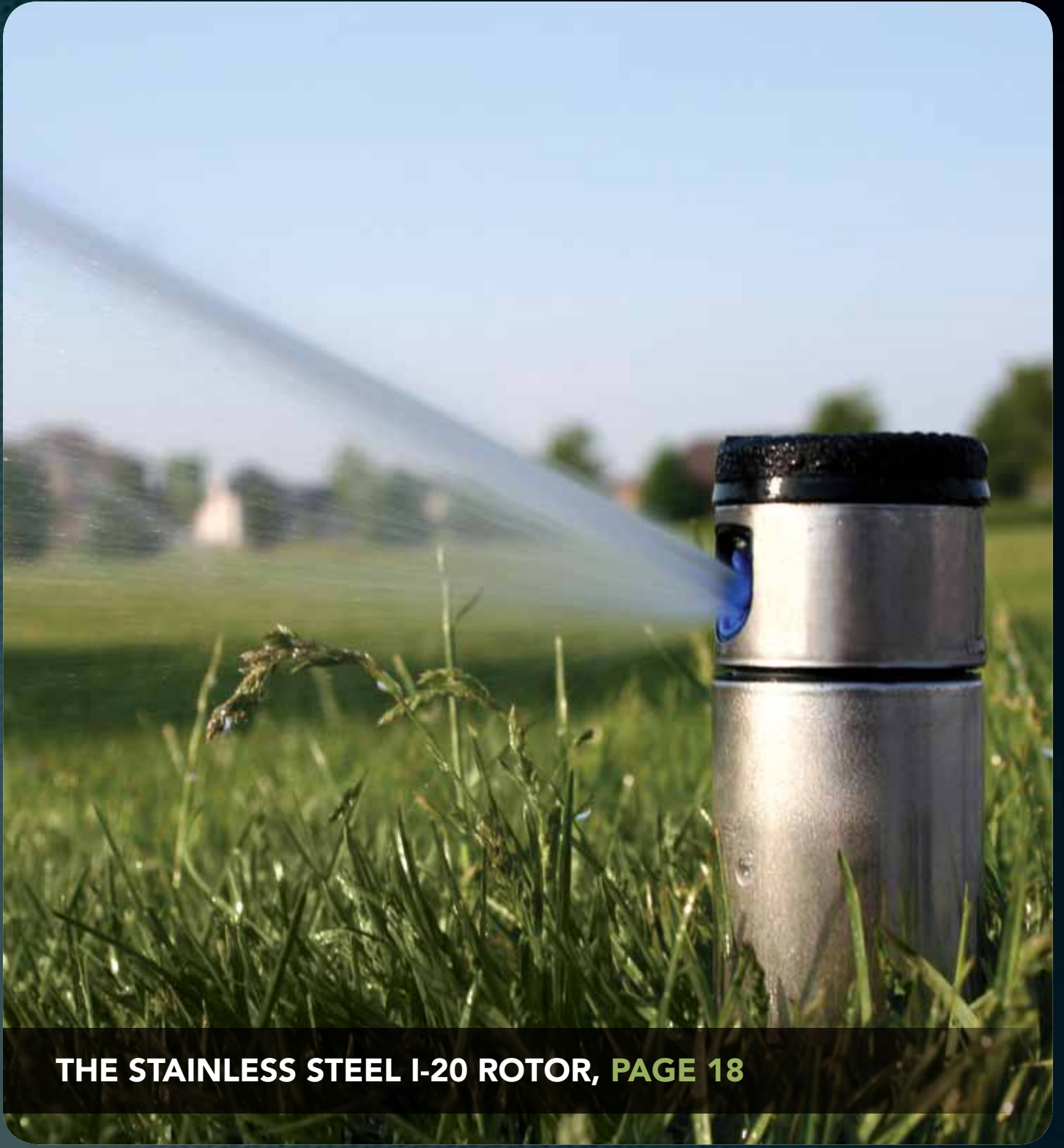

THE STAINLESS STEEL I-20 ROTOR, PAGE 18



TAKE COMMAND. Even the best system will fall short without the brains to back it up. With a Hunter controller at the helm, smart irrigation becomes simple irrigation with user-friendly operation, water-conserving features, and optional modularity.

CONTROLLERS

COMPARISON CHART

	X-CORE	PCC	PRO-C	ICC	I-CORE	ACC	SVC*	WVS*	XC HYBRID*
APPLICATIONS									
Residential	•	•	•				•	•	•
Light commercial		•	•				•	•	•
Commercial				•	•		•	•	•
High-end commercial						•	•	•	•
TYPE									
Fixed	•	•					•	•	•
Modular			•	•	•	•			
Decoder					•	•			
Indoor	•	•	•						
Outdoor	•	•	•	•	•	•	•	•	•
FEATURES									
Number of stations	2, 4, 6, 8	6, 9, 12, 15	3 to 15	8 to 48	6 to 42 [†] 1 to 48 [‡]	12 to 42 [†] 1 to 99 [‡]	1, 2, 4	1, 2, 4	4, 6, 8, 10, 12
Independent programs	3	3	3	4	4	6	Program by station	Program by station	3
Start times per program	4	4	4	8	8 (A, B, C) 16 (D)	10	9	9	4
Max. station run time (hrs)	4	6	6	12	12	6	4	4	4

* Battery controller
[†] Conventional controller
[‡] Decoder controller

ADVANCED FEATURES

AUTOMATIC SHORT CIRCUIT PROTECTION

Automatic short circuit protection, found in all Hunter AC powered controllers, automatically detects electrical faults typically caused by wiring issues or damage. Shorted stations are skipped, allowing watering to continue for those stations that are not faulty. No fuses to blow or internal circuit breakers to trip that can result in completely disabling irrigation.

X-CORE, PCC, PRO-C, ICC, I-CORE, ACC

CYCLE AND SOAK

Water-saving feature that allows the operator to specify a maximum run time for each single station, followed by a minimum soak time, to prevent runoff from slopes or saturated soil. The operator can enter any run time, and the controller will automatically divide it into cycles to allow the water to be absorbed during the soak periods. The feature is adjustable by individual station for unique soil and site conditions.

ICC, I-CORE, ACC

DELAY BETWEEN STATIONS

A delay in watering between individual stations as the controller steps sequentially through zones of irrigation. The delay may range from a few seconds, to permit slow-closing valves time to shut down, or much longer to allow pressure tanks, etc., to refill or recharge.

X-CORE, PCC, PRO-C, ICC, I-CORE, ACC

SEASONAL ADJUSTMENT

This feature allows for quick adjustments to irrigation run times through a percentage scale. During peak season, set the seasonal adjust to 100%. If weather conditions require less water, enter the appropriate percentage value (i.e. 50%) to cut down irrigation run times without the need to adjust each station in the program. Hunter offers three different ways to use Seasonal Adjustment to reduce water usage:

Globally: Provides a seasonal adjustment value to all controller programs (available on most Hunter controllers)

Monthly: Allows user to program seasonal adjustment values for each month of the year (available on I-Core controller). The controller will automatically change the programmed seasonal adjustment value at the first day of every month.

Daily (Solar Sync ET sensor): Implements an automatic daily adjustment based on measured local weather (available for most Hunter controllers)

X-CORE, PCC, PRO-C, ICC, I-CORE, ACC, XC HYBRID

EASY RETRIEVE™

A manual back-up utility that stores a complete controller's schedule and setup information in back-up memory. This allows the saved watering schedule to be restored at any time. This can be used to set a controller back to the initial settings after tampering or at the beginning of a new season.

X-CORE, PCC, PRO-C, I-CORE, ACC, XC HYBRID

EVENT DAY OFF PROGRAMMING

Day(s) of the week can be programmed Off in advance, so that irrigation does not occur regardless of program interval schedules. For example, if the gardener mows the lawn on Saturday, the Event Day Off feature allows Saturday to be programmed Off, so that watering will not occur.

PCC, PRO-C, I-CORE

NO WATER WINDOW

User-specified periods of time during which the controller will not allow automatic irrigation. No Water Window can be used to comply with local watering restrictions or to prevent conflicts with pedestrian traffic. This setting does not affect manual watering options for local maintenance.

I-CORE, ACC

PROGRAMMABLE RAIN DELAY

A user-specified number of days for the controller to remain in Off mode, but then automatically revert to automatic irrigation. This will prevent watering during an extended period of inclement weather, but will resume watering automatically without requiring a return visit to the controller. The controller displays the number of days remaining before watering resumes.

X-CORE, PCC, PRO-C, ICC, I-CORE, ACC, XC HYBRID

QUICK CHECK™

This feature allows for the quick diagnosis of wiring problems to valves in the field instead of checking each field wiring circuit for potential problems. Quick Check can detect a field wiring short and displays an "ERR" and station number on the display.

X-CORE, PCC, PRO-C, ICC, I-CORE, ACC

REAL TIME FLOW MONITORING

This feature permits connection of a flow meter to recognize high or low flow conditions and react automatically to alarms. The controller learns typical flows for each zone of irrigation and then monitors performance during automatic irrigation. When incorrect flows are detected, the controller can identify the faulty station and shut it down. Used with a normally-closed Master Valve. Alarm parameters are user-programmable. Flow totals are also recorded in controller memory to verify system water usage.

I-CORE, ACC

SENSOR PROGRAMMABILITY

The ability to specify which program or stations will be shut down in response to a specific sensor alarm. This allows stations or programs unaffected by the sensor to continue automatic operations.

X-CORE, PCC, PRO-C, I-CORE, ACC, XC HYBRID

SIMULTANEOUS STATION GROUPS

The ability to group stations into larger irrigation units that run together within automatic programs. This permits consolidation of large systems into fewer items to program and can be used to control system flow in high capacity installations.

ICC, I-CORE, ACC

TOTAL RUN TIME CALCULATOR

This feature adds up all run times, and calculates the total duration of a program or to instantly display the full length of an irrigation cycle. This information can be used to determine the time of day at which watering will end.

PCC, PRO-C, I-CORE, ACC

NON-VOLATILE MEMORY

This feature offers protection against unreliable power, retaining current time, day, and program data.

X-CORE, PCC, PRO-C, ICC, I-CORE, ACC, XC HYBRID

X-CORE

APPLICATION

NUMBER OF STATIONS

TYPE

Residential

2, 4, 6, 8

Fixed

THIS ENTRY-LEVEL CONTROLLER NOW GETS SMART WITH THE OPTIONAL SOLAR SYNC.

FEATURES

- Number of stations: 2, 4, 6, 8
- Type: Fixed
- Enclosures: Indoor and outdoor
- Independent programs: 3
- Start times per program: 4
- Max. station run time: 4 hrs
- Warranty period: 2 years

ADVANCED FEATURES

- Easy Retrieve™ memory
- Compatible with Hunter Klik sensors and other micro-switch type weather sensors
- One touch manual start and advance for easy manual operation
- Rain sensor bypass
- Programmable rain delay: 1 to 7 days
- Test program allows for quick system checks
- Manual cycle
- Quick Check™
- = Detailed descriptions on pages 64 and 65
- Non-volatile memory
- Automatic short circuit protection
- Seasonal adjustment (global): 10% to 150% (in 10% increments)
- Delay between stations (maximum): 4 hrs
- Sensor programmable by zone
- Remote control operation with Hunter ROAM and ICR remotes
- Automatic daily weather-based scheduling with optional Hunter Solar Sync sensor

ELECTRICAL SPECIFICATIONS

Transformer input: 120 VAC or 230/240 VAC (international model)
 Transformer output (24 VAC): 1 A
 Station output (24 VAC): 0.56 A
 P/MV output (24 VAC): 0.56 A

Simultaneous station operation (includes master valve): 3 valves
 Pump/master valve
 Sensor inputs: 1
 Operating temperature: 0° F to 140° F

APPROVALS

CE, UL, cUL, C-tick, FCC



Plastic indoor:
6½" H x 5¾" W x 2" D



Plastic outdoor:
8¾" H x 7" W x 3¾" D

SPECIFICATIONBUILDER

www.hunterindustries.com/XCORE

MODELS	TRANSFORMER	INDOOR/ OUTDOOR	OPTIONS
XC-2 = 2 Stations (indoor model only)	00 = 120 VAC 01 = 230/240 VAC	(blank) = Outdoor model i = Indoor model	(blank) = No option E = 230/240 VAC with European connections A = 230/240 VAC with Australian connections (outdoor model has internal transformer with cord)
XC-4 = 4 Stations			
XC-6 = 6 Stations			
XC-8 = 8 Stations			

EXAMPLES

XC-200i	2-Station 120 VAC indoor controller, with plastic cabinet
XC-400	4-Station 120 VAC outdoor controller, with plastic cabinet
XC-600i	6-Station 120 VAC indoor controller, with plastic cabinet
XC-800	8-Station 120 VAC outdoor controller, with plastic cabinet

CONTROLLERS

PCC

APPLICATION

Residential/Light Commercial

NUMBER OF STATIONS

6, 9, 12, 15

TYPE

Fixed

THE PRO-C CONVENTIONAL'S FIXED-STATION CONTROL IS A COST-EFFECTIVE CHOICE.

FEATURES

- Number of stations: 6, 9, 12, 15
- Type: Fixed
- Enclosures: Indoor and outdoor
- Independent programs: 3
- Start times per program: 4
- Max. station run time: 6 hrs
- Warranty period: 2 years

ADVANCED FEATURES

- Easy Retrieve™ memory
- Compatible with Hunter Klik sensors and other micro-switch type weather sensors
- One touch manual start and advance for easy manual operation
- Rain sensor bypass
- Programmable rain delay: 1 to 7 days
- Manual cycle
- Test program allows for quick system checks
- Quick Check™
- Non-volatile memory
- Automatic short circuit protection
- = Detailed descriptions on pages 64 and 65
- Seasonal adjustment (global): 5% to 300% (in 5% increments)
- Delay between stations (maximum): 4 hrs
- Sensor programmable by zone
- Total run time calculator
- Event day off programming
- Central control compatible with Hunter IMMST™
- Remote control operation with Hunter ROAM and ICR remotes
- Automatic daily weather-based scheduling with optional Hunter Solar Sync sensor or ET system

ELECTRICAL SPECIFICATIONS

Transformer input: 120 VAC or 230/240 VAC (international model)
 Transformer output (24 VAC): 1 A
 Station output (24 VAC): 0.56 A
 P/MV output (24 VAC): 0.56 A

Simultaneous station operation (includes master valve): 3 valves
 Pump/master valve
 Sensor inputs: 1
 Operating temperature: 0° F to 140° F

APPROVALS

CE, UL, cUL, C-tick, FCC



Plastic indoor:
8¼" H x 9½" W x 3¾" D



Plastic outdoor:
9" H x 10" W x 4½" D

SPECIFICATIONBUILDER

www.hunterindustries.com/PCC

MODELS	TRANSFORMER	INDOOR/ OUTDOOR	OPTIONS
PCC-6 = 6 Stations	00 = 120 VAC 01 = 230/240 VAC	(blank) = Outdoor model i = Indoor model	(blank) = No option SOL = Solar Sync™ E = 230/240 VAC with European connections A = 230/240 VAC with Australian connections (outdoor model has internal transformer with cord)
PCC-9 = 9 Stations			
PCC-12 = 12 Stations			
PCC-15 = 15 Stations			

EXAMPLES

PCC-1200i - A	12-Station indoor controller 230/240 VAC and plastic cabinet
PCC-600	6-Station outdoor controller 120 VAC and plastic cabinet
PCC-901i - E	9-Station indoor controller 230/240 VAC and plastic cabinet
PCC-900 - SOL	9-Station outdoor controller 120 VAC with Solar Sync
PCC-900i - SOL	9-Station indoor controller 120 VAC with Solar Sync

PRO-C

APPLICATION
Residential/Light Commercial

NUMBER OF STATIONS
3 to 15

TYPE
Modular

MODULARITY MEANS COMPLETE CUSTOMIZATION FROM 3 TO 15 STATIONS.

FEATURES

- Number of stations: 3 to 15
- Type: Modular
- Enclosures: Indoor and outdoor
- Independent programs: 3
- Start times per program: 4
- Max. station run time: 6 hrs
- Warranty period: 2 years

ADVANCED FEATURES

- Easy Retrieve™ memory
 - Compatible with Hunter Klik sensors and other micro-switch type weather sensors
 - One touch manual start and advance for easy manual operation
 - Rain sensor bypass
 - Programmable rain delay: 1 to 7 days
 - Manual cycle
 - Test program allows for quick system checks
 - Quick Check™
 - Non-volatile memory
 - Automatic short circuit protection
 - Seasonal adjustment (global): 5% to 300% (in 5% increments)
 - Delay between stations (maximum): 4 hrs
 - Sensor programmable by zone
 - Total run time calculator
 - Event day off programming
 - Central control compatible with Hunter IMMS™
 - Remote control operation with Hunter ROAM and ICR remotes
 - Automatic daily weather-based scheduling with optional Hunter Solar Sync sensor or ET system
- = Detailed descriptions on pages 64 and 65

ELECTRICAL SPECIFICATIONS

Transformer input: 120 VAC or 230/240 VAC (international model)
 Transformer output (24 VAC): 1 A
 Station output (24 VAC): 0.56 A
 P/MV output (24 VAC): 0.56 A

Simultaneous station operation (includes master valve): 3 valves
 Pump/master valve
 Sensor inputs: 1
 Operating temperature: 0° F to 140° F

APPROVALS

CE, UL, cUL, C-tick, FCC



Plastic indoor:
8¼" H x 9½" W x 3¾" D



Plastic outdoor:
9" H x 10" W x 4½" D

SPECIFICATIONBUILDER

www.hunterindustries.com/PROC

BASE MODELS	OPTIONS
PC-300i = 3-Station indoor Pro-C controller, plug-in transformer	(blank) = No option
PC-300 = 3-Station outdoor Pro-C controller, internal transformer	
PC-301i = International version 3-Station indoor Pro-C controller, plug-in transformer	E = 230/240 VAC with European connections A = 230/240 VAC with Australian connections (outdoor model has internal transformer with cord)
PC-301 = International version 3-Station outdoor Pro-C controller, internal transformer	

STATION EXPANSION MODULES

PCM-300 = 3-Station plug-in module: Use to increase station count from 3 to 6, 6 to 9, and 9 to 12
 PCM-900 = 3-Station plug-in module: Use to increase station count from 6 to 15 only



EXAMPLES

PC-300i	3-Station indoor base unit, and plastic cabinet
PC-600i	3-Station indoor base unit, one PCM-300 module, and plastic cabinet
PC-900i	3-Station indoor base unit, two PCM-300 modules, and plastic cabinet
PC-1200	3-Station outdoor base unit, three PCM-300 modules, and plastic cabinet
PC-1500	3-Station outdoor base unit, one PCM-300 module, one PCM-900 module, and plastic cabinet
PC-601i - E	3-Station indoor base unit, one PCM-300 module, 230/240 VAC, and plastic cabinet

CONTROLLERS

ICC

APPLICATION: **Commercial** NUMBER OF STATIONS: **8 to 48** TYPE: **Modular**

CUSTOMIZABLE UP TO 48 STATIONS, THIS COMMERCIAL CONTROLLER KNOWS WHAT YOU NEED.

FEATURES

- Number of stations: 8 to 48
- Type: Modular
- Enclosure: Outdoor
- Independent programs: 4
- Start times per program: 8
- Max. station run time: 12 hrs
- Warranty period: 5 years

ADVANCED FEATURES

- Compatible with Hunter Klik sensors and other micro-switch type weather sensors
- One touch manual start and advance for easy manual operation
- Rain sensor bypass
- Programmable rain delay: 1 to 7 days
- Manual cycle
- Test program allows for quick system checks
- Quick Check™
- Non-volatile memory
- Automatic short circuit protection
- Seasonal adjustment (global): 10% to 150% (in 10% increments)
- Delay between stations (maximum): 10 hrs
- Simultaneous program operation: Program D can run concurrently with A, B, or C
- Cycle and Soak
- Central control compatible with Hunter IMMST™
- Remote control operation with Hunter ROAM and ICR remotes
- Automatic daily weather-based scheduling with optional Hunter Solar Sync sensor or ET system

•• = Detailed descriptions on pages 64 and 65

ELECTRICAL SPECIFICATIONS

Transformer input: 120/240 VAC, 50/60 Hz
 Transformer output (24 VAC): 1.4 A
 Dual voltage transformer (120/240 VAC)
 Station output (24 VAC): 0.56 A
 P/MV output (24 VAC): 0.28 A

Simultaneous station operation (includes master valve): 5 valves
 Pump/master valve
 Sensor inputs: 1
 Operating temperature: 0° F to 140° F

APPROVALS

CE, UL, cUL, C-tick, FCC

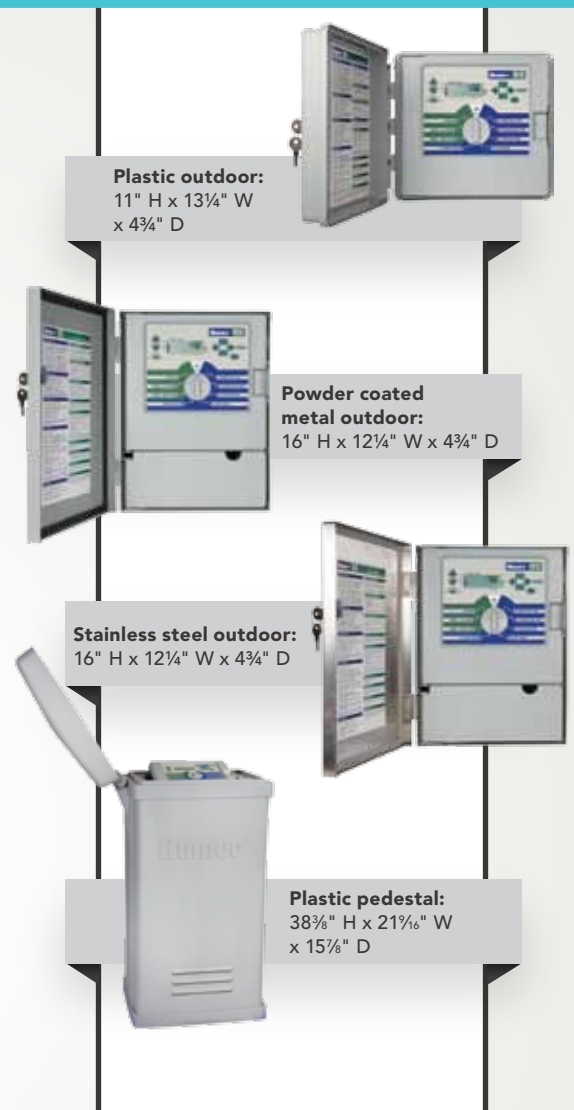

CONTROLLERS

SPECIFICATIONBUILDER

www.hunterindustries.com/ICC

BASE MODELS	OPTIONS USER INSTALLED
ICC-800-PL = 8-Station ICC controller, internal transformer, plastic cabinet	(blank) = No option PED = Optional metal pedestal for metal cabinet models
ICC-801-PL = International version, 8-station ICC controller, internal transformer, plastic cabinet	PED-SS = Optional stainless steel pedestal for stainless steel cabinet models
ICC-800-M = 8-Station ICC controller, internal transformer, metal cabinet	PWB = Pedestal wiring board needed for both PED and PED-SS options
ICC-800-SS = 8-Station ICC controller, internal transformer, stainless steel cabinet	
ICC-800-PP = 8-Station ICC controller, internal transformer, plastic pedestal	

STATION EXPANSION MODULES
ICM-400 = 4-Station plug-in module used to increase station count by 4.
ICM-800 = 8-Station plug-in module used to increase station count by 8.
Plastic cabinet = Expands to 32 stations Metal cabinet = Expands to 48 stations Stainless steel cabinet = Expands to 48 stations Plastic pedestal = Expands to 48 stations



EXAMPLES

ICC-800-M	8-Station base unit, metal cabinet
ICC-1201-PL	8-Station base unit, one ICM-400 module, international version, and plastic cabinet
ICC-1600-SS	8-Station base unit, one ICM-800 module, and stainless cabinet
ICC-2000-PL	8-Station base unit, one ICM-800 module, one ICM-400 module, and plastic cabinet
ICC-2401-PL	8-Station base unit, two ICM-800 modules, international version, and plastic cabinet
ICC-2800-PP	8-Station base unit, two ICM-800 modules, one ICM-400 module, and plastic pedestal
ICC-3200-PL	8-Station base unit, three ICM-800 modules, and plastic cabinet

EXAMPLES (METAL CABINETS)

ICC-3600-M	8-Station base unit, three ICM-800 modules, one ICM-400 module, and metal cabinet
ICC-4000-M	8-Station base unit, four ICM-800 modules, and metal cabinet
ICC-4400-M	8-Station base unit, four ICM-800 modules, one ICM-400, and metal cabinet
ICC-4800-M	8-Station base unit, five ICM-800 modules, and metal cabinet

I-CORE

APPLICATION

Commercial

NUMBER OF STATIONS

6 to 42

TYPE

Modular

THE NEXT GENERATION OF COMMERCIAL CONTROL.

FEATURES

- Number of stations: 6 to 42
- Type: Modular
- Enclosure: Outdoor
- Independent programs: 4
- Start times per program: 8 (A, B, C); 16 (D)
- Max. station run time: 12 hrs
- Warranty period: 5 years

ADVANCED FEATURES

- Easy Retrieve™ memory
- Compatible with Hunter Klik sensors and other micro-switch type weather sensors
- One touch manual start and advance for easy manual operation
- Rain sensor bypass
- Programmable rain delay
- Manual cycle
- Test program allows for quick system checks
- Quick Check™
- Non-volatile memory
- Automatic short circuit protection
- Seasonal adjustment (global): 0% to 300% (in 1% increments)
- Seasonal adjustment (monthly)
- Delay between stations (maximum): 9 hrs
- Sensor programmable by zone
- Simultaneous program operation: Any 2
- Total run time calculator
- Cycle and Soak
- No water window
- Event day off programming
- Backlit display makes it easy to program in low light applications
- Real time flow monitoring
- Factory installed SmartPort®
- Multiple language programming (6 languages)
- Remote control operation with Hunter ROAM and ICR remotes
- Automatic daily weather-based scheduling with optional Hunter Solar Sync sensor

•• = Detailed descriptions on pages 64 and 65

ELECTRICAL SPECIFICATIONS

Transformer input: 120/240 VAC, 50/60 Hz
 Transformer output (24 VAC): 1.4 A
 Dual voltage transformer (120/240 VAC)
 Station output (24 VAC): 0.56 A
 P/MV output (24 VAC): 0.56 A

Simultaneous station operation (includes master valve): 5 valves
 Pump/master valve
 Sensor inputs: Plastic: 2; metal: 3
 Operating temperature: 0° F to 140° F

APPROVALS

CE, UL, cUL, C-tick, FCC



Plastic outdoor:
11" H x 13¼" W x 4¾" D



Powder coated metal outdoor:
12¾" H x 15½" W x 6¼" D



Plastic pedestal:
38¾" H x 21¼" W x 15½" D

SPECIFICATIONBUILDER

www.hunterindustries.com/ICORE

BASE MODELS

IC-600-PL = 6-Station controller, indoor/outdoor, plastic cabinet
IC-601-PL = International version, 6-Station controller, indoor/outdoor, plastic cabinet
IC-600-M = 6-Station controller, indoor/outdoor, metal cabinet
IC-600-PP = 6-Station controller, indoor/outdoor, plastic pedestal

STATION EXPANSION MODULES

ICM-600 = 6-Station plug-in module used to increase station count by 6.
Plastic cabinet = Expands to 30 stations
Metal cabinet = Expands to 42 stations
Plastic pedestal = Expands to 42 stations

EXAMPLES

IC-600-PL	6-Station base unit with plastic cabinet	IC-3000-PP	6-Station base unit, with plastic pedestal, and four ICM-600 modules
IC-1201-PL	6-Station base unit, with plastic cabinet, and one ICM-600 module (international version)	IC-3600-M	6-Station base unit, with metal cabinet, and five ICM-600 modules
IC-1800-PL	6-Station base unit, with plastic cabinet, and two ICM-600 modules	IC-4200-M	6-Station base unit, with metal cabinet, and six ICM-600 modules
IC-2401-PL	6-Station base unit, with plastic cabinet, and three ICM-600 modules (international version)		



I-Core's unique "bridge" modules activate the existing terminal strips.

CONTROLLERS

DUAL

APPLICATION
Commercial

NUMBER OF STATIONS
6 to 48

TYPE
Decoder

USE DUAL TO CONVERT THE I-CORE TO A CUTTING EDGE TWO-WIRE CONTROLLER.

MODULE AND DECODER FEATURES

- Decoder station sizes available: 1, 2
- Max. distance to decoder, 14 AWG wire path: 5,000 ft; 12 AWG wire path 7,500 ft.
- Max. recommended distance, decoder to solenoid: 100 ft
- Field programmable
 - DUAL decoder module display and push button programming makes it easy to program decoders at the controller itself
 - DUAL decoders can be field programmed with the Hunter ICD-HP. No need to remove decoders from the two-wire path
- Decoder module displays decoder operation and diagnostic information
- Can operate up to 48 stations of combined decoder and conventional control making system retrofit easy
- DUAL-S external surge protection
- Waterproof connectors for connection to two-wire path supplied with all DUAL decoders and DUAL-S surge protection
- Number of 2-wire paths: 3

APPROVALS

CE, UL, cUL, C-tick

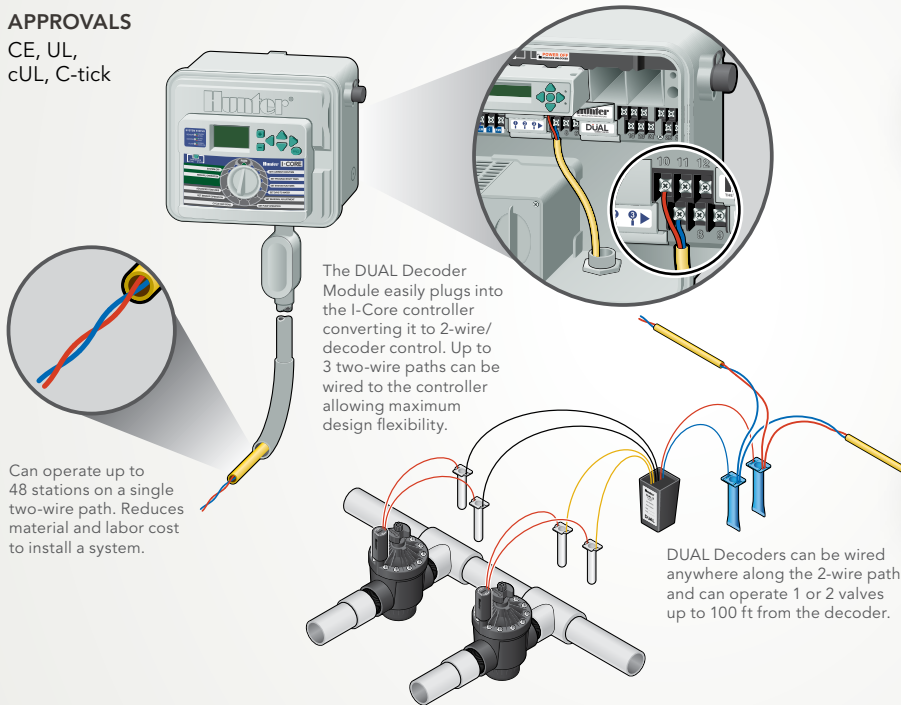

DUAL decoders and surge arrester:
3" H x 1¾" W x 2" D



DUAL decoder module:
1½" H x 4¾" W x 4" D

CONTROLLERS

SPECIFICATIONBUILDER

www.hunterindustries.com/DUAL

BASE MODELS

IC-600-PL = 6-Station controller, indoor/outdoor, plastic cabinet
IC-601-PL = International version, 6-Station controller, indoor/outdoor, plastic cabinet
IC-600-M = 6-Station controller, indoor/outdoor, metal cabinet
IC-600-PP = 6-Station controller, indoor/outdoor, plastic pedestal

DUAL MODELS

DUAL48M = DUAL decoder output module. Plug-in module converts any ICORE controller to 2-wire decoder system (up to 48 stations maximum)
DUAL-1 = DUAL 1-station decoder (includes 2 DBRY-6 connectors)
DUAL-2 = DUAL 2-station decoder (includes 2 DBRY-6 connectors)
DUAL-S = DUAL surge arrester (includes 4 DBRY-6 connectors)

ID WIRE MODEL GUIDE

14 AWG (2 MM²) STANDARD DECODER CABLE (UP TO 10,000 FT./3KM) **12 AWG (3.3 MM²) LONG RANGE, HEAVY-DUTY DECODER CABLE**

ID1GRY	Gray jacket	ID2GRY	Gray jacket
ID1PUR	Purple jacket	ID2PUR	Purple jacket
ID1YLW	Yellow jacket	ID2YLW	Yellow jacket
ID1ORG	Orange jacket	ID2ORG	Orange jacket
ID1BLU	Blue jacket	ID2BLU	Blue jacket
ID1TAN	Tan jacket	ID2TAN	Tan jacket

ACC

APPLICATION
High-End Commercial

NUMBER OF STATIONS
12 to 42

TYPE
Modular

ACC IS THE MOST POWERFUL CONTROLLER FOR LARGE, SOPHISTICATED SITES.

FEATURES

- Number of stations: 12 to 42
- Type: Modular
- Enclosure: Outdoor
- Independent programs: 6
- Start times per program: 10
- Max. station run time: 6 hrs
- Warranty period: 5 years

ADVANCED FEATURES

- Easy Retrieve™ memory
- Compatible with Hunter Klik sensors and other micro-switch type weather sensors
- One touch manual start and advance for easy manual operation
- Rain sensor bypass
- Programmable rain delay
- Manual cycle
- Flow and alarm logs
- Test program allows for quick system checks
- Quick Check™
- Non-volatile memory
- Automatic short circuit protection
- Seasonal adjustment (global): 0% to 300% (in 1% increments)
- Seasonal adjustment (by program)
- Delay between stations (maximum): 6 hrs
- Sensor programmable by program
- = Detailed descriptions on pages 64 and 65
- Two pump/master valves programmable by station
- Simultaneous program operation: 6
- Total run time calculator
- Cycle and Soak
- No water window
- Backlit display makes it easy to program in low light applications
- Real time flow monitoring
- Factory installed SmartPort®
- Central control compatible with Hunter IMMS™
- Alphanumeric names for each program, station, or group
- Simultaneous station operation (includes master valve): 14 valves
- Automatic daily weather-based scheduling with optional Hunter Solar Sync sensor or ET system

ELECTRICAL SPECIFICATIONS

Transformer input: 120/240 VAC, 50/60 Hz
 Transformer output (24 VAC): 4.0 A
 Dual voltage transformer (120/240 VAC)
 Station output (24 VAC): 0.56 A
 P/MV output (24 VAC): 0.32 A
 Pump/master valve: 2, normally closed
 Sensor inputs: 4
 Operating temperature: 0° F to 140° F

APPROVALS

CE, UL, cUL, C-tick, FCC



Powder coated metal outdoor:
12¾" H x 15½" W x 6¼" D



Powder coated metal pedestal:
37" H x 15½" W x 5" D
(pedestal only)



Plastic pedestal:
38¾" H x 21⅞" W x 15⅞" D

SPECIFICATIONBUILDER

www.hunterindustries.com/ACC

BASE MODELS	OPTIONS USER INSTALLED	STATION EXPANSION MODULES
ACC-1200 = 12-Station base unit controller, expands to 42 stations, metal cabinet	(blank) = No option PED = Optional metal pedestal for metal cabinet models	ACM-600 = 6-Station plug-in module for use with the ACC-1200 series controllers
ACC-1200PP = 12-Station base unit controller, expands to 42 stations, plastic pedestal		AGM-600 = 6-Station plug-in module for use with the ACC-1200 series controllers (extreme service lightning protection version)

EXAMPLES

ACC-1200	12-Station base unit, metal cabinet
ACC-1800	12-Station base unit with one ACM-600 module, and metal cabinet
ACC-2400 - PED	12-Station base unit, two ACM-600 modules and a metal pedestal
ACC-3000	12-Station base unit with three ACM-600 modules, and metal cabinet
ACC-3600	12-Station base unit with four ACM-600 modules, and metal cabinet
ACC-4200	12-Station base unit with five ACM-600 modules, and metal cabinet



ACM-600

CONTROLLERS

ACC-99D

APPLICATION
High-End Commercial

NUMBER OF STATIONS
1 to 99

TYPE
Decoder

THIS DECODER VERSION OF THE POWERFUL ACC PUTS CONTROL IN COMMAND.

Includes all features of the ACC Controller on page 72

DECODER FEATURES

- Decoder station sizes available: 1, 2, 4, 6
- Sensor decoder available
- Max. distance to decoder, 14 AWG wire path: 10,000 ft
- Max. distance to decoder, 12 AWG wire path: 15,000 ft
- Max. recommended distance, decoder to solenoid: 150 ft
- Field programmable
- ICD-HP wireless handheld programmer compatible
- Two-way communications
- Surge suppression: Internal (ground wire included)
- Dual pump/master valve outputs may be assigned to decoders
- Wire path connectors included with each decoder
- Number of wire paths: 6
- Automatic daily weather-based scheduling with optional Hunter Solar Sync sensor or ET system

APPROVALS

CE, UL, cUL, C-tick, FCC



Decoders:
ICD-100, 200, ICD-SEN: 3 3/8" H x 1 1/2" W x 1/2" D
ICD-400, 600: 3 3/8" H x 1 3/4" W x 1 1/2" D
Height does not include wire leads

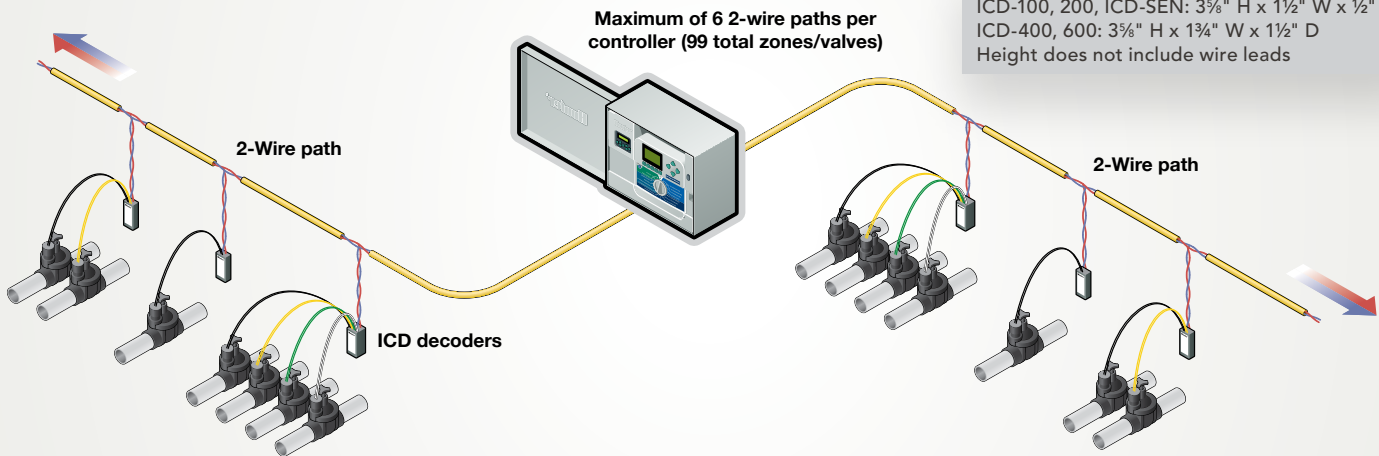

CONTROLLERS

SPECIFICATIONBUILDER

www.hunterindustries.com/ACCD

BASE MODELS		OPTIONS USER INSTALLED	IDWIRE SPECIFY SEPARATELY
ACC-99D = 2-Wire decoder controller with 99 station capacity, metal cabinet		(blank) = No option PED = Optional metal pedestal for metal cabinet models	14 AWG STANDARD DECODER CABLE (UP TO 10,000 FT)
ACC-99DPP = 2-Wire decoder controller with 99 station capacity, plastic pedestal			ID1GRY = Gray jacket
EXAMPLES			ID1PUR = Purple jacket
ACC-99D	2-wire decoder controller, metal cabinet		ID1YLW = Yellow jacket
ACC-99D - PED	2-wire decoder controller, metal pedestal		ID1ORG = Orange jacket
ACC-99DPP	2-wire decoder controller, plastic pedestal		ID1BLU = Blue jacket
DECODERS SPECIFY SEPARATELY			ID1TAN = Tan jacket
ICD-100 = Single-station decoder with surge suppression and ground wire			12 AWG HEAVY-DUTY DECODER CABLE (UP TO 15,000 FT)
ICD-200 = 2-station decoder with surge suppression and ground wire			ID2GRY = Gray jacket
ICD-400 = 4-station decoder with surge suppression and ground wire			ID2PUR = Purple jacket
ICD-600 = 6-station decoder with surge suppression and ground wire			ID2YLW = Yellow jacket
ICD-SEN = 2-input sensor decoder with surge suppression and ground wire			ID2ORG = Orange jacket
			ID2BLU = Blue jacket
			ID2TAN = Tan jacket

Note: Each decoder includes 2 waterproof connectors for red and blue wires.

HFS

APPLICATION
Commercial

TYPE
Flow Sensor

www.hunterindustries.com/HFS

KNOW THE FLOW WITH HFS, A SIMPLE AND ECONOMICAL SOLUTION FOR METERING AND REACTING TO ACTUAL FLOW CONDITIONS.

FEATURES

- Simple two wire connection to ACC and I-Core controllers (up to 1000 ft/300 m)
- Feeds flow data (gallons or liters) to controller, for flow recording and monitoring purposes
- Robust waterproof construction (used with appropriate FCT tees for pipe diameter, see table)
- Provides station level flow monitoring for reaction to high or low flow conditions
- Prevents damage and waste from leaks and breaks in piping system



Impeller-type flow meter, requires FCT for pipe installation (sold separately)

SPECIFICATIONBUILDER

FLOW RANGE

FLOW SENSOR DIAMETER	OPERATING RANGE (GPM)		
	MINIMUM*	SUGGESTED MAXIMUM †	MAXIMUM (for sensor)
1"	6	17	50
1-1/2"	13	35	100
2"	20	55	200
3"	40	120	300
4"	60	200	400

* Minimum recommended flow for the highest flow zone for your system.

† Good design practice dictates the maximum flow not to exceed 5 ft/sec. Suggested maximum flow is based upon Class 200 IPS plastic pipe.

NOTE: Highest flow zone within irrigation system should not be more than 75% maximum available system flow.

MODELS

HFS = ACC and I-CORE compatible flow sensor

DESCRIPTION

Includes sensor only. Use with ACC and I-CORE controllers, sensor requires FCT for pipe installation (sold separately)

EXAMPLE

HFS

MODELS

SPECIFY SEPARATELY

- FCT-100 = 1" Schedule 40 sensor receptacle tee
- FCT-150 = 1-1/2" Schedule 40 sensor receptacle tee
- FCT-158 = 1-1/2" Schedule 80 sensor receptacle tee
- FCT-200 = 2" Schedule 40 sensor receptacle tee
- FCT-208 = 2" Schedule 80 sensor receptacle tee
- FCT-300 = 3" Schedule 40 sensor receptacle tee
- FCT-308 = 3" Schedule 80 sensor receptacle tee
- FCT-400 = 4" Schedule 40 sensor receptacle tee

EXAMPLE

FCT-200

ICD-HP

APPLICATION
Commercial

TYPE
Decoder Programmer

www.hunterindustries.com/ICDHP

THE INDISPENSABLE FIELD TOOL FOR THE DECODER PROFESSIONAL.

FEATURES

- Waterproof programming cup
- Communicates with decoder through plastic case— wireless electro-magnetic induction saves waterproof connectors
- Compatible with Hunter ICD or DUAL series decoders
- USB powered for shop or office use; 4 x AA batteries for field use
- All test leads and cables included in durable, foam-padded carrying case
- Turn decoder stations on and view solenoid status, current in milliamps, and more
- Program or re-program decoder stations, whether new or installed
- Program any station numbers in any order, or skip stations for future expansion
- Simplifies setup and diagnostics for sensor decoders
- Sensor test functions for Klik and Flow sensors, plus built-in multimeter
- Backlit adjustable display
- 6 international operating languages
- Warranty period: 5 years

ELECTRICAL SPECIFICATIONS

Power input: 4 x AA batteries, or standard USB connector (included)

Communications: Wireless induction, range 1" (25 mm)

Fused test leads for unpowered decoder functions

APPROVALS

FCC, CE, C-tick (no license required)



ICD-HP: Handheld programmer

SPECIFICATIONBUILDER

MODEL

ICD-HP = Handheld programmer

DESCRIPTION

Wireless handheld decoder programmer, includes all test and power leads, programming cup, and rugged carrying case

EXAMPLE

ICD-HP

ROAM

APPLICATION
Residential/Light Commercial

RANGE
1000'

www.hunterindustries.com/ROAM

THE ROAM REMOTE ALLOWS FOR CONTROLLER OPERATION UP TO 1000 FEET.

FEATURES

- Designed to work with Hunter ACC, I-Core, ICC, Pro-C, PCC, and X-Core controllers through a SmartPort® connection
- 128 programmable addresses for use of multiple ROAM remotes in the same neighborhood
- Variable run times to adjust run time without modifying regular program
- Maximum stations supported: 240
- Run times: 1 to 90 minutes
- Range: Up to 1000 ft (line of sight)
- Transmitter power source: 4 AAA batteries (included)
- Receiver power source: 24 VAC, 10 mA (provided by controller)
- System operating frequency: 433 MHz
- FCC approved



Transmitter and receiver:
7" H x 2¼" W x 1¼" D

SmartPort®

ROAM and ICR remote controls require the installation of a SmartPort wiring harness. This consists of a connector that is wired to the SmartPort terminal on the controller and will accept either the ROAM or ICR remote receiver.



SPECIFICATIONBUILDER

MODELS

- ROAM-KIT = Transmitter, receiver (SmartPort® wiring harness, and 4 AAA batteries included)
- ROAM-TR = Transmitter (4 AAA batteries included)
- ROAM-R = Receiver
- ROAM-WH = SmartPort wiring harness (length: 6 ft)
- SRR-SCWH = Shielded SmartPort wiring harness (length: 25 ft)

EXAMPLES

- ROAM-KIT**
- ROAM-R**

ICR

APPLICATION
Commercial

RANGE
2 Miles

www.hunterindustries.com/ICR

REMOTELY ACCESS CONTROLLERS UP TO TWO MILES AWAY.

FEATURES

- Up to 2 mile range for remote manual operation of Hunter irrigation systems
- Designed to work with Hunter ACC, I-Core, ICC, Pro-C, PCC, and X-Core controllers through a SmartPort® connection
- 128 different programmable addresses
- Variable run times to change run time without modifying regular program
- Display shows remaining battery life
- Maximum stations supported: 240
- Run times: 1 to 90 minutes
- Large LCD display, push-button operation
- Transmitter power source: 4 AA alkaline batteries (included)
- Receiver power source: 24 VAC, from controller through a SmartPort® connector
- System operating frequency: 27 MHz band
- SmartPort can be mounted up to 50' from controller (use SRR-SCWH shielded cable wiring harness)
- FCC approved: No FCC license required
- Rugged plastic carrying case included



Transmitter (no antenna):
6½" H x 3¼" W x 1¼" D
Receiver (no antenna):
6¼" H x 3" W x 1¼" D

SPECIFICATIONBUILDER

MODELS

- ICR-KIT = Transmitter, receiver SmartPort® wiring harness, and carrying case
- ICR-TR = Handheld transmitter (4 AA batteries included)
- ICR-R = Receiver unit (SmartPort wiring harness included)
- ICR-CASE = Plastic carrying case
- ROAM-WH = SmartPort wiring harness (length: 6 ft/1.8 m)
- SRR-SCWH = Shielded SmartPort wiring harness (length: 25 ft)

OPTIONS

- (blank) = No option
- A = Australia and other international markets

EXAMPLES

- ICR-KIT**

SVC

APPLICATION: Residential/Commercial
 NUMBER OF STATIONS: 1, 2, 4
 TYPE: Fixed

THE SVC BRINGS BASIC, BATTERY-POWERED CONTROL TO SITES WITH NO ELECTRICITY.

FEATURES

- Battery powered
- Number of stations: 1, 2, 4
- Type: Fixed
- Enclosure: Outdoor
- Program by station
- Start times per program: 9
- Max. station run time: 4 hrs
- Warranty period: 2 years

ADVANCED FEATURES

- Compatible with Hunter Klik sensors and other micro-switch type weather sensors (wireless sensors not compatible)
- One touch manual start and advance for easy manual operation
- Programmable rain delay
- Manual cycle
- Non-volatile memory
- Low battery indicator
- Waterproof (to 12 ft)

ELECTRICAL SPECIFICATIONS

Sensor inputs: 1
 Power source: 9-volt battery
 Operates DC latching solenoids only (P/N 458200)
 Operating temperature: 0° F to 140° F

APPROVALS

IP68, CE

Various configurations



Plastic outdoor:
2" W x 3¼" D

SPECIFICATIONBUILDER www.hunterindustries.com/SVC

MODELS

SVC-100 = Single station controller (DC latching solenoid included)
SVC-200 = 2-Station controller (DC latching solenoid ordered separately)
SVC-400 = 4-Station controller (DC latching solenoid ordered separately)
SVC-100-VALVE = Single station controller with PGV-101G valve and DC latching solenoid (NPT threads)
SVC-100-VALVE-B = Single station controller with PGV-101G-B valve and DC latching solenoid (BSP threads)

EXAMPLES

SVC-100
SVC-100-VALVE

WVS

APPLICATION: Residential/Commercial
 NUMBER OF STATIONS: 1, 2, 4
 TYPE: Fixed

WVS IS A BATTERY-POWERED, WIRELESS PROGRAMMABLE CONTROLLER FOR HARD-TO-REACH PLACES.

FEATURES

- Battery powered
- Number of stations: 1, 2, 4
- Type: Fixed
- Enclosure: Outdoor
- Program by station
- Start times per program: 9
- Max. station run time: 4 hrs
- Warranty period: 2 years

ADVANCED FEATURES

- Compatible with Hunter Klik sensors and other micro-switch type weather sensors (wireless sensors not compatible)
- One touch manual start and advance for easy manual operation
- Programmable rain delay
- Manual cycle
- Non-volatile memory
- Low battery indicator
- Waterproof (to 12 ft)
- Wireless remote programming

ELECTRICAL SPECIFICATIONS

Simultaneous station operation: Up to 4
 Sensor inputs: 1
 Power source: 9-volt battery
 Operates DC latching solenoids only (P/N 458200)
 Operating temperature: 0° F to 140° F
 Frequency of operation: 900 MHz ISM band
 No FCC license required

APPROVALS

IP68, CE



WVP (left): 11½" L x 3" W x 2" H
 WVC (right): 3¼" D x 5" H

SPECIFICATIONBUILDER www.hunterindustries.com/WVS

MODELS

WVC-100 = Single station wireless controller (DC latching solenoid ordered separately)
WVC-200 = 2-Station wireless controller (DC latching solenoid ordered separately)
WVC-400 = 4-Station wireless controller (DC latching solenoid ordered separately)
WVP = Wireless valve programmer to be used with wireless valve controllers

OPTIONS

(blank) = 900 MHz ISM band (US/Australia)
E = 869.85 MHz (Europe)

EXAMPLES

WVC-100
WVP

XC HYBRID

APPLICATION
Residential/Commercial

NUMBER OF STATIONS
4, 6, 8, 10, 12

TYPE
Fixed

GET THE POWER WITHOUT THE PLUG WITH THE BATTERY-POWERED XC HYBRID.

FEATURES

- Battery or AC powered
- Number of stations: 4, 6, 8, 10, 12 (plastic); 6, 12 (stainless)
- Type: Fixed
- Enclosures: Indoor/outdoor plastic; outdoor stainless
- Independent programs: 3
- Start times per program: 4
- Max. station run time: 4 hrs
- Warranty period: 2 years

ADVANCED FEATURES

- Easy Retrieve™ memory
- Compatible with Hunter Klik sensors and other micro-switch type weather sensors (wireless sensors not compatible)
- One touch manual start and advance for easy manual operation
- Rain sensor bypass
- Programmable rain delay: 1 to 7 days
- Manual cycle
- = Detailed descriptions on pages 64 and 65
- Test program allows for quick system checks
- Non-volatile memory
- Seasonal adjustment (global): 10% to 150%
- Delay between stations (maximum): 4 hrs
- Sensor programmable by zone

ELECTRICAL SPECIFICATIONS

Operates DC latching solenoids only
 Pump/master valve
 Sensor inputs: 1
 Operating temperature: 0° F to 140° F
 Uses 6 AA batteries (plastic model)
 Uses 6 C batteries (stainless model)

OPTIONAL

24 VAC input transformer:
 120 VAC plug in transformer (P/N 526500)
 240 VAC plug in transformer (European P/N 545700)
 240 VAC plug in transformer (Australian P/N 545500)
 DC latching solenoids (P/N 458200)
 Pole mount for stainless steel model

APPROVALS

CE, UL, cUL, C-tick



Plastic indoor/outdoor:
8 5/8" H x 7" W x 3 3/4" D



Stainless steel outdoor:
9 3/4" H x 7 3/8" W x 4 1/4" D



Stainless steel outdoor:
9 3/4" H x 7 3/8" W x 4 1/4" D
Stainless steel pole: 4'

CONTROLLERS

SPECIFICATIONBUILDER

www.hunterindustries.com/XCHYBRID

MODELS
XCH-400 = 4-Station indoor/outdoor controller
XCH-600 = 6-Station indoor/outdoor controller
XCH-600-SS = 6-Station outdoor controller, stainless
XCH-800 = 8-Station indoor/outdoor controller
XCH-1000 = 10-Station indoor/outdoor controller
XCH-1200 = 12-Station indoor/outdoor controller
XCH-1200-SS = 12-Station outdoor controller, stainless

EXAMPLE

XCH-400	4-Station indoor/outdoor controller
XCH-600-SS	6-Station outdoor controller, stainless

OPTIONS SPECIFY SEPARATELY

- XCHSPOLE = Stainless steel mounting pole (4 ft)
- XCHSPB = Stainless steel mounting bracket (required for pole)

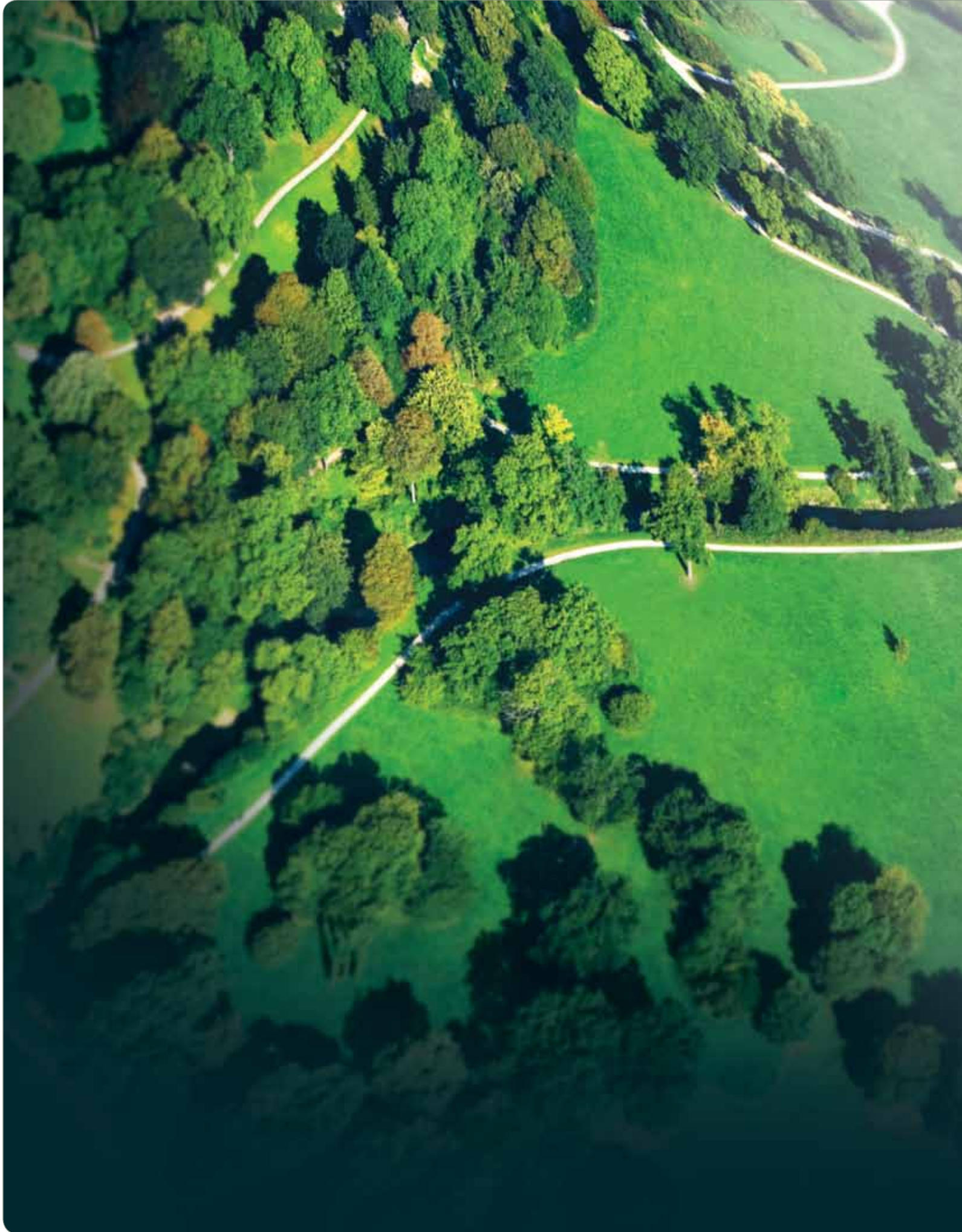

An aerial photograph of a lush green landscape. A winding road or path cuts through the fields, leading towards a large, dense cluster of trees. The scene is captured from a high angle, showing the curvature of the earth.

CENTRAL CONTROL SYSTEM

SEE THE WORLD FROM A DIFFERENT VIEW. Make that every view. With Hunter's powerful IMMS 3.0, any Site can be controlled centrally and simply. With two-way communication, flow monitoring, remote shut down, and interactive map graphics, this software leaves no system unseen.

IMMS 3.0

SITES
Up to 100

CONTROLLERS
Up to 10,000

STATIONS
Up to 990,000

IMMS IS DESIGNED FOR WIDE-AREA CENTRAL CONTROL, INCLUDING ET AND FLOW REPORTING.

FEATURES

- Windows-based programming and communications software
- Total control of each controller's functions
- Graphical user interface with customizable map-based navigation
- Flow monitoring and reporting with Hunter ACC controllers
- Alarm reporting and detailed irrigation history reports
- Wireless and hardwired communications options
- Controller sharing of communications channels to reduce communications costs

ADVANCED FEATURES

- Optional IMMS-ET provides automatic evapo-transpiration adjustment to adjust watering to local conditions
- Uses cost-effective local ET sensors, sharing ACC communications
- Point-specific ET with no monthly fees
- Full station level ET database with plant, soil, and sprinkler information
- Measures and adjusts for natural rainfall events

KEY SPECIFICATIONS

Operating system: Microsoft XP, Vista, or Windows 7, 32 or 64 bit
 Minimum RAM: 512 MB
 Minimum screen resolution: 1024 x 768
 Storage: At least 100 MB disk space

COMPATIBLE CONTROLLERS

IMMS is optimized for the Hunter ACC controller and accessories (including decoder controllers). IMMS is also compatible with Hunter model ICC and Pro-C controllers, with reduced functionality.

COMPATIBLE SENSORS

HFS: Hunter Flow-Clik sensor for ACC controllers (one per controller). Provides flow total reporting and flow alarm monitoring with diagnostic shutdowns in real time.
Cliks: Each controller should have its own rain sensor for fast rain shutdowns. All Hunter Clik sensors are compatible with ACC and other IMMS controllers.
ET Sensor: ET Sensor platform is for use with IMMS-ET software.
 ET Sensor is added to selected ACC controllers, to report local conditions. This local ET data has no additional monthly charges and can be shared through the software to create schedules for other controllers in the same micro-climate (including ICC or Pro-C controllers). Add as many ET Sensors as needed to sample all micro-climates.



Add a visual dimension to central control with background map graphics.



Track flow and other vital statistics in both charts and spreadsheets.



Station level symbols can be positioned over background images from any source.

SPECIFICATIONBUILDER

www.hunterindustries.com/IMMS

SOFTWARE		
MODELS	DESCRIPTION	NOTES
IMMS3CD	IMMS 3 graphics central control software	Custom images not included
IMMS-ET-CD	Optional ET automatic weather adjustment software (requires IMMS3CD base model)	Requires an ET Sensor at one or more ACC controller locations

IMMS 3.0

SITES
Up to 100

CONTROLLERS
Up to 10,000

STATIONS
Up to 990,000

COMMUNICATIONS COMPONENTS

ACC: Communications options are installed inside the ACC controller cabinet. No additional enclosures or power are necessary for these options.

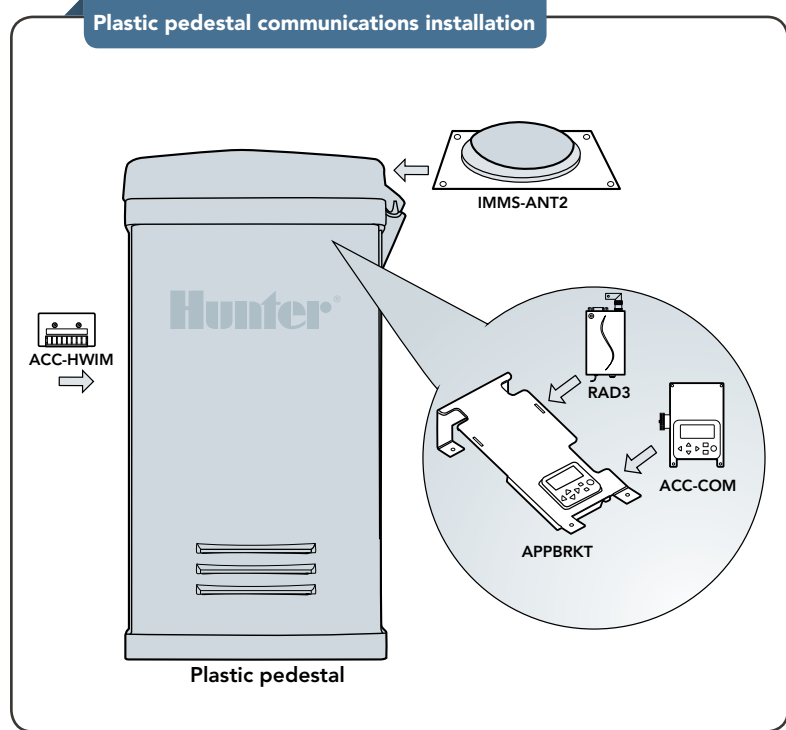
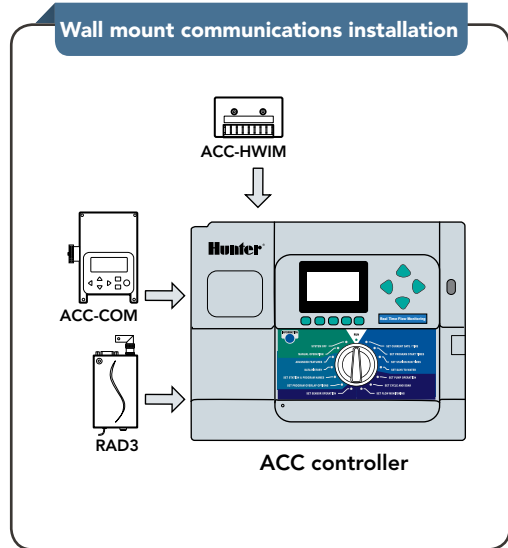

SPECIFICATIONBUILDER

www.hunterindustries.com/IMMS

COMMUNICATION OPTIONS FOR ACC INTERFACE		SPECIFY SEPARATELY
MODELS	OPTIONS	PURPOSE
ACC-COM-HWR = Hardwire/radio module	(blank) = No option	Supports hardwire and radio communication options
ACC-COM-POTS = Dial-up modem module (also supports radio and hardwire)		Supports dial-up telephone line input in addition to hardwire and radio communication sharing
ACC-COM-GSM = CSD cellular module (also supports radio and hardwire)	E = International frequencies	Supports GSM mobile input in addition to hardwire and radio communication sharing (cell service required)

EXAMPLES

ACC-COM-HWR	Hardwire/radio module
ACC-COM-POTS	Dial-up modem module
ACC-COM-GSM - E	CSD cellular module for international frequencies

USER INSTALLED OPTIONS		SPECIFY SEPARATELY
MODELS	DESCRIPTION	PURPOSE
ACC-HWIM	Hardwire interface module required for hardwire connections	Provides surge protected terminals for hardwired cable connections
RAD3	UHF radio module (North America), 450-470 MHz	UHF radio module for wireless connections (<i>license and antenna required and not included</i>)
RAD460INT	UHF radio module (International), 440-480 MHz <i>Consult factory for other international frequency ranges</i>	UHF radio module for wireless connections, international only (<i>license and antenna required and not included</i>)
APPBRKT	Communication bracket for plastic pedestals	Holds Com modules and accessories in plastic pedestal (<i>not required in wall mounts</i>)

BASE	MODELS	OPTIONS	PURPOSE	SPECIFY SEPARATELY
IMMS-CCC	Hardwire central interface	None = 120 VAC (North America)	Hardwired central interface for connection to Site via direct wire (GCBL cable), supplied with USB cable for connection to central computer, and plug-in transformer	
		E = 230/240 VAC (Europe/international power)		
		A = 230/240 VAC (Australia)		
GCBL*	None = up to 4000' spool 100 = 100'/30 m 300 = 300'/90 m 500 = 500'/150 m		Cable for all IMMS hardwired communications	

* GCBL available in 1000'/300 m increments (up to 4000'/1200 m)

IMMS 3.0

SITES
Up to 100

CONTROLLERS
Up to 10,000

STATIONS
Up to 990,000

SYSTEM CONFIGURATIONS (ACC CONTROLLERS)

- 1** Determine how you will reach the first controller on each Site.
 - Dial-up landline: Add ACC-COM-POTS to controller
 - Hardwire cable: Add one IMMS-CCC at the computer, and ACC-COM-HWR plus one ACC-HWIM at the controller
 - GSM cell phone: Add ACC-COM-GSM to controller
- 2** Determine how that first controller will reach the other controllers on the Site.
 - If by radio, add one RAD3 (US) or RAD460INT (international) plus antenna to the controller
 - If by hardwire cable, add one ACC-HWIM (if it is not already present as in 1)
- 3** Equip the other controllers. Add one ACC-COM-HWR to each controller, plus:
 - One ACC-HWIM when hardwire connection will be necessary
 - One RAD3 plus antenna when radio connections are necessary

SPECIFICATIONS

ACC-COM-HWR, POTS, GSM, GSM-E
 3¼" x 4½" x 1¾"
 Powered internally via data connection
 Mounted internally to ACC controller
 RAD3, RAD460INT: 450-470 MHz, 1 W, 12.5 kHz bandwidth
 ACC-HWIM: Hardwire interface module for 4-20 ma loop communications, includes 8 color-coded terminals for GCBL connection. Installs inside ACC controller cabinets or pedestals.

HARDWARE COMMUNICATIONS CABLE

GCBL shielded, two twisted pair 18 AWG wire with ground wire, up to 10,000' between each device

Consult factory for detailed system design information.

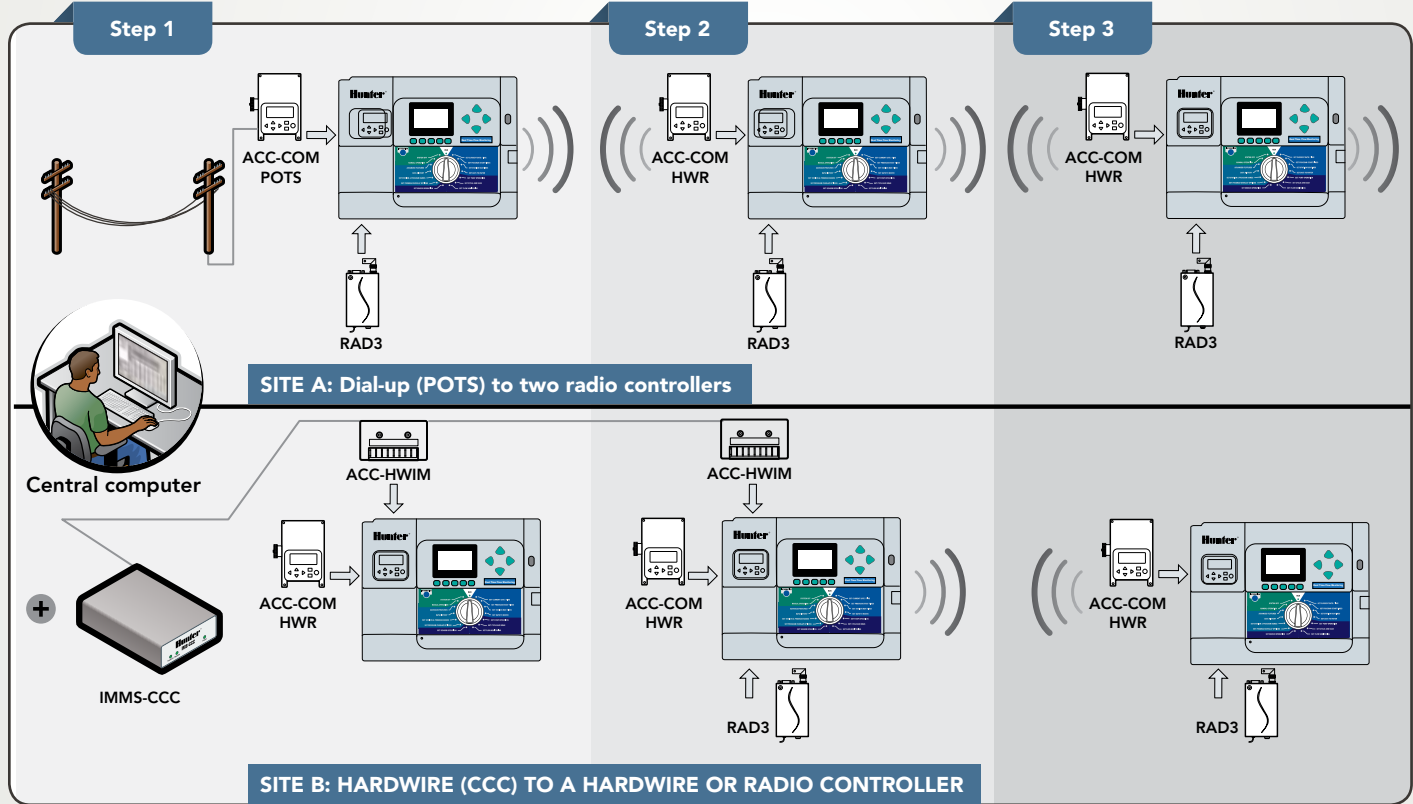

SPECIFICATIONBUILDER

www.hunterindustries.com/IMMS

RADIO ANTENNA OPTIONS		SPECIFY SEPARATELY
MODELS	DESCRIPTION	
IMMSANT2	Omni-directional antenna for plastic pedestal lid installation	
IMMSANT3	Omni-directional antenna for wall or pole mount installation	
IMMSANTYAGI3	High efficiency directional antenna for pole installation	
RA5M	High gain omni-directional mast antenna for roof or pole installations	

CENTRAL

SENSORS



OUTWIT THE WEATHER. No matter what the weather forecast may say, Hunter sensors are ready for any weather at any time. The entire lineup offers a level of additional protection unmatched in the industry. **No matter rain, ice, wind, or sun, a Hunter sensor is ready for it all.**

MINI-CLI[®]

www.hunterindustries.com/MINICLIK

MINI-CLI IS THE SIMPLEST WAY TO SHUT DOWN SYSTEMS DURING RAINFALL.

FEATURES

- Easily installs on any automatic irrigation system
- Debris tolerant for reliable operation and no unnecessary shutdowns
- Can be set to shut system off from 1/8" to 1" of rainfall
- Includes 25' of 20 gauge sheathed, two-conductor, UL-approved wire
- Optional user-installed metal gutter mount for Mini-Click[®] (order SGM)
- Warranty period: 5 years

SPECIFICATIONS

Switch rating: 24 VAC, 5 A

Wiring: Typically interrupts the common ground wire between the solenoid valves and the controller

UL listed

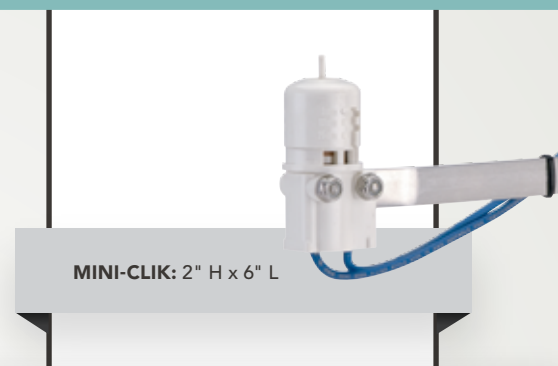

SPECIFICATIONBUILDER

MODEL	OPTIONS
MINI-CLI	(blank) = No option HV = High voltage model for 110/220 VAC applications C = Conduit mount NO = Normally open switch

USER INSTALLED OPTION SPECIFY SEPARATELY

SGM = Optional gutter mount

EXAMPLES

MINI-CLI	Mini-Click rain sensor
MINI-CLI - C	Mini-Click rain sensor with conduit mount

FREEZE-CLI[®]

www.hunterindustries.com/FREEZECLICK

WHEN FRIGID TEMPS SET IN, FREEZE-CLI STOPS SPRINKLERS TO AVOID DANGEROUS, ICY CONDITIONS.

FEATURES

- Installs easily with no adjustment needed
- Accurate temperature sensing shuts system off when air temperature reaches 37° F
- Used with other sensors to enhance overall efficiency of irrigation systems
- Warranty period: 5 years

Note: Not intended for agricultural applications.

SPECIFICATIONS

Switch rating: 24 VAC, 5 A

Wiring: Typically interrupts the common ground wire between the solenoid valves and the controller

UL listed



SPECIFICATIONBUILDER

MODEL	OPTIONS
FREEZE-CLI	(blank) = No option REV = Reverse switching

EXAMPLE

FREEZE-CLI

WIND-CLI[®]

www.hunterindustries.com/WINDCLI

WHEN HIGH WINDS KICK IN, WIND-CLI[®] SHUTS SYSTEMS DOWN.

FEATURES

- Adjusts to activate at various wind speeds
- Two types of operation: "normally open" or "normally closed" wiring
- Adjustable reset wind speeds
- Can control fountain systems to eliminate overspray in windy conditions
- Warranty period: 5 years

SPECIFICATIONS

Switch rating: 24 VAC, 5 A maximum

Wind speed adjustment:

Actuation speed: 12 to 35 mph

Reset speed: 8 to 24 mph

Mounts: Slip fits over 2" PVC pipe or attaches to ½" conduit with adapter (supplied with unit)



WIND-CLI: 4" H
Wind vane diameter: 5"

SPECIFICATIONBUILDER

MODEL

WIND-CLI = Wind sensor

EXAMPLE

WIND-CLI



SENSORS

MINI WEATHER STATION

www.hunterindustries.com/MWS

MWS HELPS ANY SYSTEM BATTLE WIND, RAIN, AND FREEZING TEMPERATURES.

FEATURES

- Compact sensor that monitors wind, rain, freezing temperatures, and shuts the irrigation system off as weather conditions require
- Installs easily on automatic irrigation system
- Set wind speed shutdown from 12 to 35 mph
- Set rain shutdown from ⅛" to 1" of rainfall
- Automatically shuts off system when temperatures fall below 37° F
- Warranty period: 5 years

SPECIFICATIONS

Electrical rating: 24 VAC, 5 A maximum

Wind vane diameter: 5"

Wind speed adjustments:

Actuation speed: 12 to 35 mph

Reset speed: 8 to 24 mph

Freeze-Click[®] temperature set point: 37° F

Mounts: Slip fits over 2" PVC pipe or attaches to ½" conduit with adapter (supplied with unit)



SPECIFICATIONBUILDER

MODEL

MWS = Wind and rain sensors

OPTIONS

(blank) = No option
FR = Combines wind, rain and freeze sensors

EXAMPLE

MWS - FR Wind and rain sensors with a freeze sensor added

RAIN-CLIK™

RAIN-CLIK'S QUICK RESPONSE™ TURNS OFF SYSTEMS THE INSTANT RAIN STARTS TO FALL.

FEATURES

Models: Rain-Click, Rain/Freeze-Click, Wireless Rain-Click, Wireless Rain/Freeze-Click

- Quick Response™ feature shuts the system off as soon as it starts raining
- Maintenance-free design with 10-year battery life
- Adjustable vent ring allows for setting of reset delay
- Rugged polycarbonate housing and metal extension arm
- Rain-Click includes 25' of 20 gauge sheathed, two-conductor, UL-approved wire

- ☁ Wire-free operation allows easy installation on new or existing systems
- ☁ Sensor operates up to 800 ft. from receiver unit
- ☁ Built-in bypass switch on receiver panel
- ☁ Wireless Rain/Freeze-Click sensor protects against ice caused by irrigation on landscapes, roads, and walkways
- ☁ Compatible with most controllers
- Warranty period: 5 years

SPECIFICATIONS

- Wiring: normally closed or normally open
- Time to turn off irrigation system: 2 to 5 minutes approx. for Quick Response
- Time to reset Quick Response: 4 hours approx. under dry, sunny conditions
- Time to reset when fully wet: 3 days approx. under dry, sunny conditions
- Operating temperature: 32° F to 130° F
- UL listed, CUL (CSA), CE
- Optional user installed gutter mount for Rain-Click (order SGM)
- Switch rating: 24 VAC, 3 A

- Freeze sensor shuts system off when temperatures fall below 37° F (Rain/Freeze-Click model)
- ☁ System operating frequency: 433 MHz
- ☁ UL listed, FCC approved, suitable for use in Australia, CUL (CSA), CE
- ☁ Communication range up to 800 ft. line of sight*
- ☁ Wireless Rain/Freeze-Click shuts system off when temperatures fall below 37° F
- ☁ Receiver input power: 24 VAC (from controller)

- = Applicable to Rain-Click only
- ☁ = Applicable to Wireless Rain-Click only
- = Applicable to Rain-Click and Wireless Rain-Click

* Consult with factory for compatibility in export markets.

APPROVAL
FCC

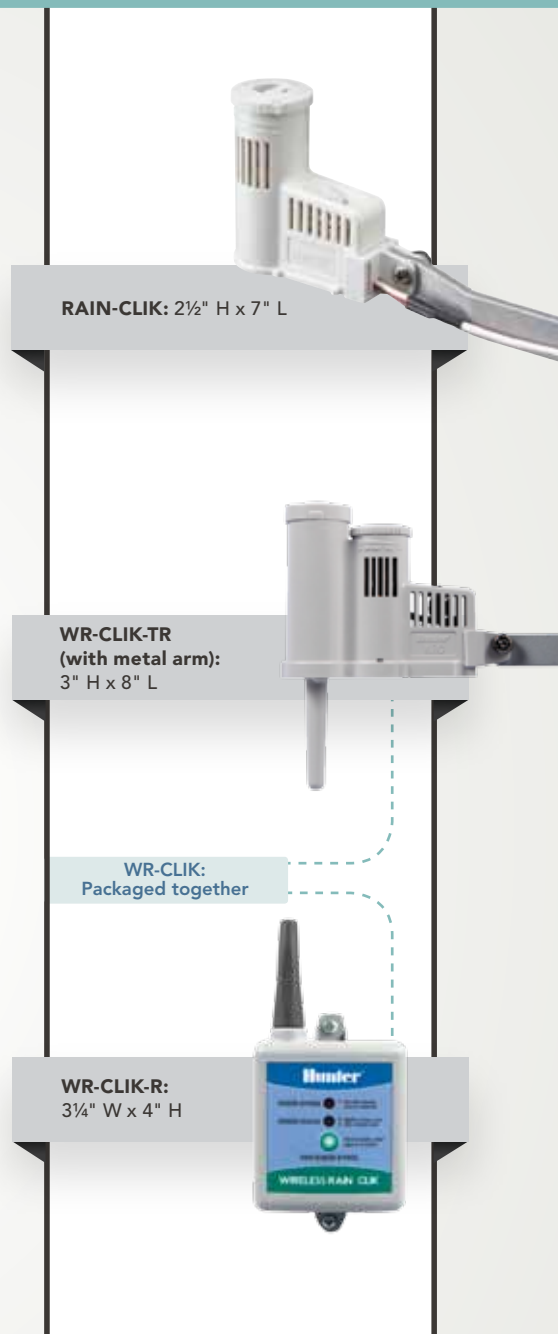

SPECIFICATIONBUILDER

www.hunterindustries.com/RAINCLIK

MODEL	OPTIONS
RAIN-CLIK = Rain-Click sensor	(blank) = No option NO = Normally open switch SGM = Optional gutter mount
RFC = Rain/Freeze-Click sensor	

MODELS
WR-CLIK = Wireless Rain-Click system
WRF-CLIK = Wireless Rain/Freeze-Click system

USER INSTALLED OPTION	SPECIFY SEPARATELY
SGM = Optional gutter mount	

USER INSTALLED OPTION	SPECIFY SEPARATELY
SGM = Optional gutter mount (included in the WRF-CLIK)	

EXAMPLES

RAIN-CLIK	Rain-Click sensor
RFC - SGM	Rain/Freeze Click sensor with gutter mount

EXAMPLES

WR-CLIK	Wireless Rain-Click system
WRF-CLIK	Wireless Rain/Freeze-Click system with gutter mount

FLOW-CLIK™

www.hunterindustries.com/FLOWCLIK

WHEN RUPTURES OR LEAKS OCCUR, FLOW-CLIK ENSURES WATER FLOW IS STOPPED IMMEDIATELY.

FEATURES

- Automatically shuts down system if an overflow condition occurs
- Calibration for precise system control: Single button allows each system to be programmed at a specified flow level
- Protects from flooding damage and erosion
- Works with all Hunter and most non-Hunter controllers
- Multi-color LED provides system status to display when power is applied, and indicate if flow is within limits
- Compatible with all commercial and residential piping systems: Large flow range provides complete flexibility
- Warranty period: 5 years



FLOW-CLIK INTERFACE PANEL

36" leads provided for easy wiring to controller (2 wires to controller 24 VAC terminals and 2 wires to sensor and terminals)

Current draw: 24 VAC, 0.025 A

Switching current: 2 A maximum

Max. distance between interface panel and sensor: 1000 ft. (18 gauge minimum wire size); 2 wires required for Flow-Clik sensor; 4 wires required for Flow-Clik IMMS™ sensor

Programmable start up delay: 0 to 300 seconds

Programmable interrupt period: 2 to 60 minutes

System status indicator light

One button system calibration to set to highest flow zone

SPECIFICATIONBUILDER

MODELS	DESCRIPTION	MODELS	SPECIFY SEPARATELY
FLOW-CLIK = Standard kit for all 24 VAC controllers	Includes sensor and interface panel, sensor requires FCT for pipe installation (sold separately)	FCT-100 = 1" Schedule 40 sensor receptacle tee	
FLOW-CLIK-IMMS = IMMS SI/CI only compatible flow sensor	Includes sensor only. Use with IMMS SI/CI only, sensor requires FCT for pipe installation (sold separately)	FCT-150 = 1-1/2" Schedule 40 sensor receptacle tee	
		FCT-158 = 1-1/2" Schedule 80 sensor receptacle tee	
		FCT-200 = 2" Schedule 40 sensor receptacle tee	
		FCT-208 = 2" Schedule 80 sensor receptacle tee	
		FCT-300 = 3" Schedule 40 sensor receptacle tee	
		FCT-308 = 3" Schedule 80 sensor receptacle tee	
		FCT-400 = 4" Schedule 40 sensor receptacle tee	

EXAMPLE

FLOW-CLIK

EXAMPLE

FCT-200

FLOW RANGE

FLOW SENSOR DIAMETER	OPERATING RANGE (GPM)		
	MINIMUM*	SUGGESTED MAXIMUM**	MAXIMUM (for sensor)
1"	6	17	50
1-1/2"	13	35	100
2"	20	55	200
3"	40	120	300
4"	60	200	400

* Minimum recommended flow for the highest flow zone for your system.

** Good design practice dictates the maximum flow not to exceed 5ft/sec. Suggested maximum flow is based upon Class 200 IPS plastic pipe.

NOTE: Highest flow zone within irrigation system should not be more than 75% maximum available system flow.

PUMP START RELAY

www.hunterindustries.com/PSR

FOR SYSTEMS THAT USE A PUMP, PSR DELIVERS RELIABILITY FOR LESS.



Compact design: Enclosure measures 6½" H x 7½" W x 4½" D

FEATURES

- Choice of three models sized accordingly to fit your particular application
- NEMA 3R rated locking plastic enclosure rated for outdoor use, weather resistance and security
- 24 VAC flying leads make it quick and easy to wire to controller
- The PSR-22 meets demanding electrical requirements for UL approval, and the PSR-52/-53 contain UL-approved relays

Electrical Specifications

Models	Single Phase		3 Phase	Max. Full Load AMPS	Max. Resistive AMPS	Coll VA		Coll VA	
	HP at 110 VAC	HP at 240 VAC	HP at 240 VAC			Inrush	(Amps)	Holding	(Amps)
PSR-22	2*	5*	N/A	22	22	31	(1.29)	7	(0.29)
PSR-52	5	7.5	N/A	40	50	56	(2.33)	6	(0.25)
PSR-53	5	7.5	10	40	50	56	(2.33)	6	(0.25)

* Approximate power

SOLAR SYNC

SOLAR SYNC MONITORS LOCAL WEATHER AND ADJUSTS IRRIGATION RUNTIMES, MAKING HUNTER CONTROLLERS SMARTER.

FEATURES

- Provides automated daily adjustment to program run times
- Rain and freeze shutoff
- Wired and wireless models available
- Gutter mount bracket included
- No Water Window programming available in most controllers (see page 65)
- Warranty period: 5 years

ELECTRICAL SPECIFICATIONS

- Maximum distance sensor to module: 200'
 - 40' of wire included in kit
 - Solar Sync compatible with Pro-C, PCC, ICC, I-Core controllers
 - Solar Sync SEN compatible with X-Core and ACC controllers
 - Rain and Freeze sensor shutdown capability included in sensor
 - ☁ Wireless sensor and receiver with 800' maximum range
 - ☁ Wireless Solar Sync compatible with Pro-C, PCC, ICC, I-Core controllers
 - ☁ Wireless Solar Sync SEN compatible with X-Core and ACC controllers
- = *Applicable to Solar Sync only*
 ☁ = *Applicable to wireless Solar Sync only*
 • = *Applicable to Solar Sync and wireless Solar Sync*

APPROVAL
FCC



SPECIFICATIONBUILDER

www.hunterindustries.com/SOLARSYNC

MODELS

SOLAR SYNC = Solar Sync sensor (40'*)
Solar Sync module (includes 10 year lithium battery and rubber module cover)

For use with PCC, Pro-C, I-Core, and ICC controllers

SOLAR SYNC-SEN† = Solar Sync sensor (module not included)

* Max. distance from sensor to controller: 40'
 † For use with X-Core and ACC controllers

EXAMPLES

SOLAR SYNC

SOLAR SYNC-SEN

MODELS

WSS = Wireless Solar Sync sensor (800'*)
Solar Sync module (includes 10 year lithium battery and rubber module cover)

For use with PCC, Pro-C, I-Core, and ICC controllers

WSS-SEN† = Wireless Solar Sync sensor only (800'*)

* Max. distance from wireless sensor to receiver: 800'
 † For use with X-Core, and ACC controllers

EXAMPLES

WSS

WSS-SEN

ET SYSTEM

FOR ADVANCED CONTROL, THE ET SYSTEM AUTOMATICALLY CREATES AN IRRIGATION PROGRAM DAILY BY MEASURING EVAPOTRANSPIRATION RATES.

FEATURES

- Calculates evapotranspiration (ET) for individual microclimate to fit the exact landscape requirements
- Specific irrigation scheduling for every zone based on the characteristics of each
- Enables compliance with local watering restrictions
- Easily upgrades Hunter SRC, PCC, Pro-C, and ICC to weather-based controllers
- Non-volatile memory
- Full range of scheduling options
- Includes 100 ft. of 18 AWG, 2-conductor for sensor installation
- WiltGuard™ technology triggers protective watering when extreme conditions threaten plants
- Warranty period: 2 years

SPECIFICATIONS

Station maximum: 48

Power input: 24 VAC, 50/60 Hz (from host controller)

Current draw: 20 mA, maximum

Max. distance, ET Sensor from module: 100'

Sensor wire: Includes 100' of UL approved wire

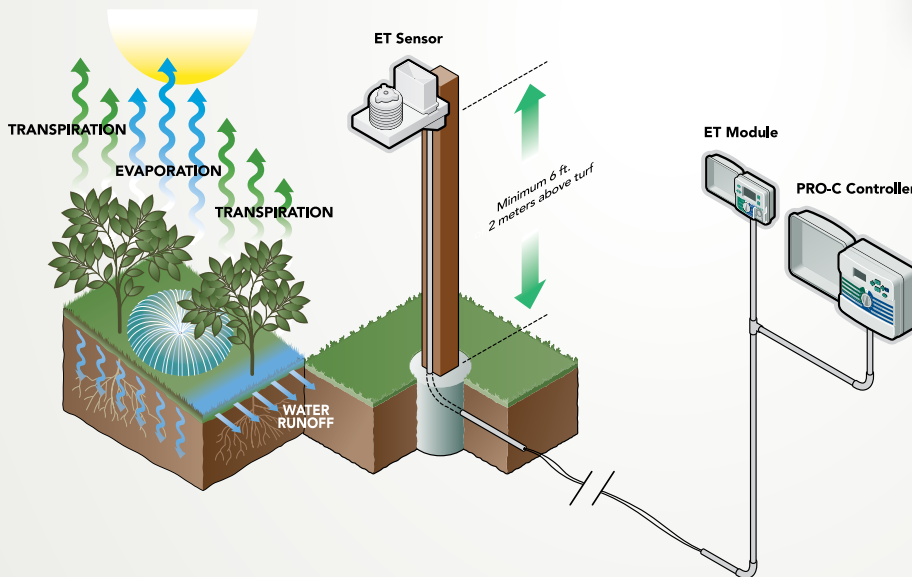

ET Sensor:
10½" H x 7¼" W x 12⅝" D

ET SYSTEM:
Packaged together

ET Module: 6" H x 4" W x 1¾" D

Dimensions

ET Sensor with pole brackets:
10½" H x 7¼" W x 13" D

ET Sensor with ET Wind:
11½" H x 7¼" W x 19⅞" D

ET Sensor and ET Wind with pole brackets: 11½" H x 7¼" W x 20¾" D

SPECIFICATIONBUILDER

www.hunterindustries.com/ETSYSTEM

MODELS SPECIFY SEPARATELY FROM CONTROLLER

ET SYSTEM = ET Sensor with outdoor interface ET Module, for direct connection to Hunter SRC, PCC, Pro-C, ICC controllers

ET WIND = Optional anemometer to gather wind speed data

ET SENSOR = ET Sensor only for use with IMMS-ET installations

EXAMPLE

ET SYSTEM



DRIP/MICRO

IRRIGATION'S SECRET WEAPON. Flowerbeds, highway medians, and groundcovers all benefit from the targeted accuracy of micro-irrigation, which puts water only where it is needed, with greatly reduced risk of runoff and waste.

PLD

APPLICATION
Residential/Commercial

FLOW RATES
0.4, 0.6, 1.0 GPH

SPECIFIC AND PRECISE, PLD DELIVERS WATER WITHOUT THE WASTE.

PLD FEATURES

- In-line pressure-compensating emitters provide consistent high-quality performance
- Built-in check valve prevents emitter clogging and wasteful runoff
- Available emitter spacing of 12", 18", or 24"
- Emitter flow rates available in 0.4, 0.6, or 1.0 GPH
- Blank tubing available (no emitters)
- Comes in 250' and 1,000' coils
- Superior flexibility and kink resistance
- Works with Drip Zone Control Kits
- 100' rolls available in models PLD 0612100, PLD 1012100, and PLD 1018100

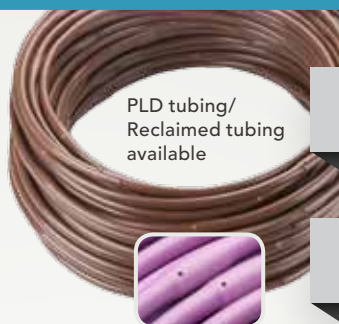

PLD tubing/
Reclaimed tubing
available

PLD FITTINGS FEATURES

- Ideal for use with all PLD drip line products
- Quick and easy connections without using tools or glue
- Handles pressures up to 50 PSI
- UV resistant
- Same color as original PLD drip line for a perfect blend under mulch

OPERATING SPECIFICATIONS

Pressure compensating, non-draining emitters Recommended filtration: 120 Mesh
Operating pressure range: 15 to 50 PSI Accepts 17 mm insert fittings

PLD Maximum Line Length Chart – 0.4 GPH*

Pressure (PSI)	Emitter Spacing		
	Maximum Lateral Lenth (ft) 12"	18"	24"
15.0	344	475	594
20.0	479	660	823
25.0	509	703	879
30.0	535	742	928
35.0	584	808	1010
40.0	627	868	1086
45.0	646	894	1119
50.0	689	957	1200

PLD Maximum Line Length Chart – 0.6 GPH*

Pressure (PSI)	Emitter Spacing		
	Maximum Lateral Lenth (ft) 12"	18"	24"
15.0	190	261	325
20.0	279	384	479
25.0	331	459	574
30.0	354	490	614
35.0	390	542	679
40.0	420	585	735
45.0	436	607	761
50.0	472	654	819

PLD Maximum Line Length Chart – 1.0 GPH*

Pressure (PSI)	Emitter Spacing		
	Maximum Lateral Lenth (ft) 12"	18"	24"
15.0	141	193	240
20.0	203	283	354
25.0	243	339	427
30.0	259	361	453
35.0	289	401	502
40.0	312	432	541
45.0	322	447	561
50.0	344	482	606

* Maximum single lateral length at 0% slope

PLD Insert Fittings

Model	Description
PLD050	Barb to 1/2" NPT Adapter
PLD075	Barb to 3/4" NPT Adapter
PLDCPL	Barb to Barb Coupling
PLDELB	Barb to Barb, 90° Elbow
PLDTEE	Barbed Tee
PLDCAP	Barb to End Cap
PLDBV	Barbed Valve
PLD075TBTEE	3/4" Female Thread x 17 mm Barb Tee
PLD-AVR	Air Relief Valve

Quick Reference Chart – GPM per 100'

Emitter (GPH)	Emitter Spacing		
	12"	18"	24"
0.4	0.67	0.44	0.33
0.6	1.00	0.67	0.50
1.0	1.67	1.11	0.83

Additional charts located on page 108



PLD-050 fitting:
1/2" MPT x 17 mm barb

PLD-075 fitting:
3/4" MPT x 17 mm barb

PLD-CPL fitting:
17 mm Barb x barb coupling

PLD-ELB fitting:
17 mm Barb x barb 90° elbow

PLD-TEE fitting:
17 mm Barb x barb tee

PLD-CAP fitting:
17 mm Barb x 1/2" MPT with cap

PLD-BV fitting:
17 mm Barb x barb shut-off valve

PLD075TBTEE:
3/4" Female thread x 17 mm barb tee

PLD-AVR:
1/2" Threaded air/vacuum relief valve

SPECIFICATIONBUILDER

www.hunterindustries.com/PLD

MODELS	SPACING	LENGTH	OPTIONS
PLD-04 = 0.4 GPH Flow	12 = 12"	100 = 100'	(blank) = No option
PLD-06 = 0.6 GPH Flow	18 = 18"	250 = 250'	R = Reclaimed
PLD-10 = 1.0 GPH Flow	24 = 24"	1K = 1,000'	
PLD-BLNK = Blank			

EXAMPLES

PLD-04 - 12 - 250	0.4 GPH landscape dripline with 12" spacing in a 250' roll
PLD-06 - 12 - 100	0.6 GPH landscape dripline with 12" spacing in a 100' roll
PLD-10 - 24 - 250 - R	1.0 GPH landscape dripline with 24" spacing in a 250' roll, with reclaimed option
PLD-BLNK - 100	100' Roll of blank tubing
PLD - AVR	1/2" MPT air relief/anti-vacuum valve

MICRO IRRIGATION

APPLICATION

Residential/Commercial

USES

Precise Area Watering

MICRO IRRIGATION WATERS WITH PINPOINT ACCURACY.

SOLO-DRIP

- Eight streams of water for accurate watering
- Fingertip cap control for flow and radius adjustment
- Operating specifications: 15 to 30 PSI
- Dimensions:
A: SD-T: 0.95" H x 0.78" W x 0.63" D
B: SD-B: 0.95" H x 0.78" W x 0.63" D
C: SD-B-STK: 6.0" H x 1.7" W x 0.63" D



Solo-Drip

HALO-SPRAY

- Large diameter, umbrella of water
- Adjust radius as needed
- Combine several for a "blanket" of water
- Operating specifications: 15 to 30 PSI
- Dimensions:
A: HS-T: 0.95" H x 0.78" W x 0.63" D
B: HS-B: 0.95" H x 0.78" W x 0.63" D
C: HS-B-STK: 6.0" H x 1.7" W x 0.63" D



Halo-Spray

TRIO-SPRAY

- Full-, half-, and quarter-circle configurations
- Functions like big sprays on a micro level
- Control knob for specific adjustment
- Operating specifications: 10 to 30 PSI
- Dimensions:
A: TS-F: 1.5" H x 0.9" W x 0.6" D
B: TS-H: 1.5" H x 0.9" W x 0.6" D
C: TS-Q: 1.5" H x 0.9" W x 0.6" D



Trio-Spray

Solo-Drip Performance Data

	Pressure (PSI)	Flow (GPH)	Diameter of Throw (ft)
Adjustable to Maximum (approx 20 clicks)	15.0	0-11	0-1.5
	20.0	0-12.5	0-1.9
	30.0	0-15.7	0-2.7

Halo-Spray Performance Data

	Pressure (PSI)	Flow (GPH)	Diameter of Throw (ft)
Adjustable to Maximum (approx 14 clicks)	15.0	0-14	0-5.8
	20.0	0-16	0-7.7
	30.0	0-20	0-11.5

Trio-Spray Performance Data

Pressure (PSI)	Flow (GPH)	SPRAY PATTERN		
		Diameter of Throw (in)	Radius of Throw (in)	
			360° x 18 Hole	180°
10.0	0-16.7	0-17	0-7	0-6
15.0	0-20.3	0-19	0-8	0-7
20.0	0-23.4	0-20	0-9	0-8
25.0	0-26.1	0-22	0-10	0-9.0
30.0	0-28.6	0-23	0-11	0-10

SPECIFICATIONBUILDER

www.hunterindustries.com/MICRO

MODELS	OPTIONS
SD = Solo-Drip	T = 10-32 Threads, 360° B = Barb, 360° B-STK = Barb with stake, 360°
HS = Halo-Spray	T = 10-32 Threads, 360° B = Barb, 360° B-STK = Barb with stake, 360°
TS = Trio-Spray	T-F = 10-32 Threads, 360° T-H = 10-32 Threads, 180° T-Q = 10-32 Threads, 90°

EXAMPLES

SD - T	Solo-Drip with 10-32 threads, 360°
HS - B	Halo-Spray with barb, 360°
TS - T-F	Trio-Spray with 10-32 threads, 360°

DRIP ZONE CONTROL KITS

APPLICATION

Residential/Commercial Micro Irrigation

DRIP CONTROL KITS BRING TOGETHER A VALVE, FILTER, AND PRESSURE REGULATOR FOR TOTAL COMMAND OF A ZONE.

FEATURES

- Factory-assembled and water-tested
- Highest quality components (SS filter screen, standard flush cap, top of the line regulator)
- Filter Sentry™ diaphragm screen cleaning system on ICZ kits
- Wide flow range to cover most micro irrigation applications

OPERATING SPECIFICATIONS

ACZ-075:

Pressure regulation: 25 or 40 PSI
Flow: 0.5 to 15 GPM (30 to 900 GPH)
Operating pressure: 20 to 120 PSI
Operating temperature: up to 150° F

PCZ-101:

Pressure regulation: 25 or 40 PSI
Flow: 0.5 to 15 GPM (30 to 900 GPH)
Operating pressure: 20 to 120 PSI
Operating temperature: up to 150° F

ICZ-101:

Pressure regulation: 25 or 40 PSI
Flow: 2 to 20 GPM (120 to 1200 GPH)
Operating pressure: 20 to 120 PSI
Operating temperature: up to 150° F

ICZ-151:

Pressure regulation: 40 PSI
Flow: 20 to 60 GPM
Operating pressure: 20 to 120 PSI
Operating temperature: up to 150° F

SOLENOID OPERATING SPECIFICATIONS

Heavy-duty solenoid: 24 VAC, 370 mA inrush current, 190 mA holding current, 60 cycles, 475 mA inrush current, 230 mA holding current, 50 cycles

FACTORY INSTALLED OPTIONS

25 or 40 PSI regulator (ACZ-075, PCZ-101, ICZ-101)

USER INSTALLED OPTIONS

Reclaimed water ID for ACZ-075 and PCZ-101 (P/N 269205)

Reclaimed water ID for ICZ-101 (P/N 561205)

Additional charts located on page 109



ACZ-075: 14¼" H x 11" L x 3" W
¾" inlet x ¾" outlet



PCZ-101: 6" H x 13" W x 3" D
1" inlet x ¾" outlet



ICZ-101: 6" H x 13" W x 3" D
1" inlet x 1" outlet



ICZ-151: 12" H x 22" L x 12" D
1½" inlet x 1" outlet

SPECIFICATIONBUILDER

www.hunterindustries.com/DRIPKITS

MODELS	OPTIONS
ACZ-075 = ¾" PGV-ASV valve with ¾" HY075 filter system	25 = 25 PSI regulator (excluding ICZ-151) 40 = 40 PSI regulator
PCZ-101 = 1" PGV globe valve with 1" HY100 filter system	
ICZ-101 = 1" ICV globe valve with 1" HY100 filter system	
ICZ-151 = 1½" ICV globe valve with 1" HY100 filter system	

EXAMPLES

ACZ-075 - 25	¾" PGV-ASV valve with ¾" HY075 filter system, and 25 PSI regulator
PCZ-101 - 25	1" PGV globe valve with 1" HY100 filter system, and 25 PSI regulator
ICZ-101 - 40	1" ICV globe valve with 1" HY100 filter system, and 40 PSI regulator

DESIGN ILLUSTRATION

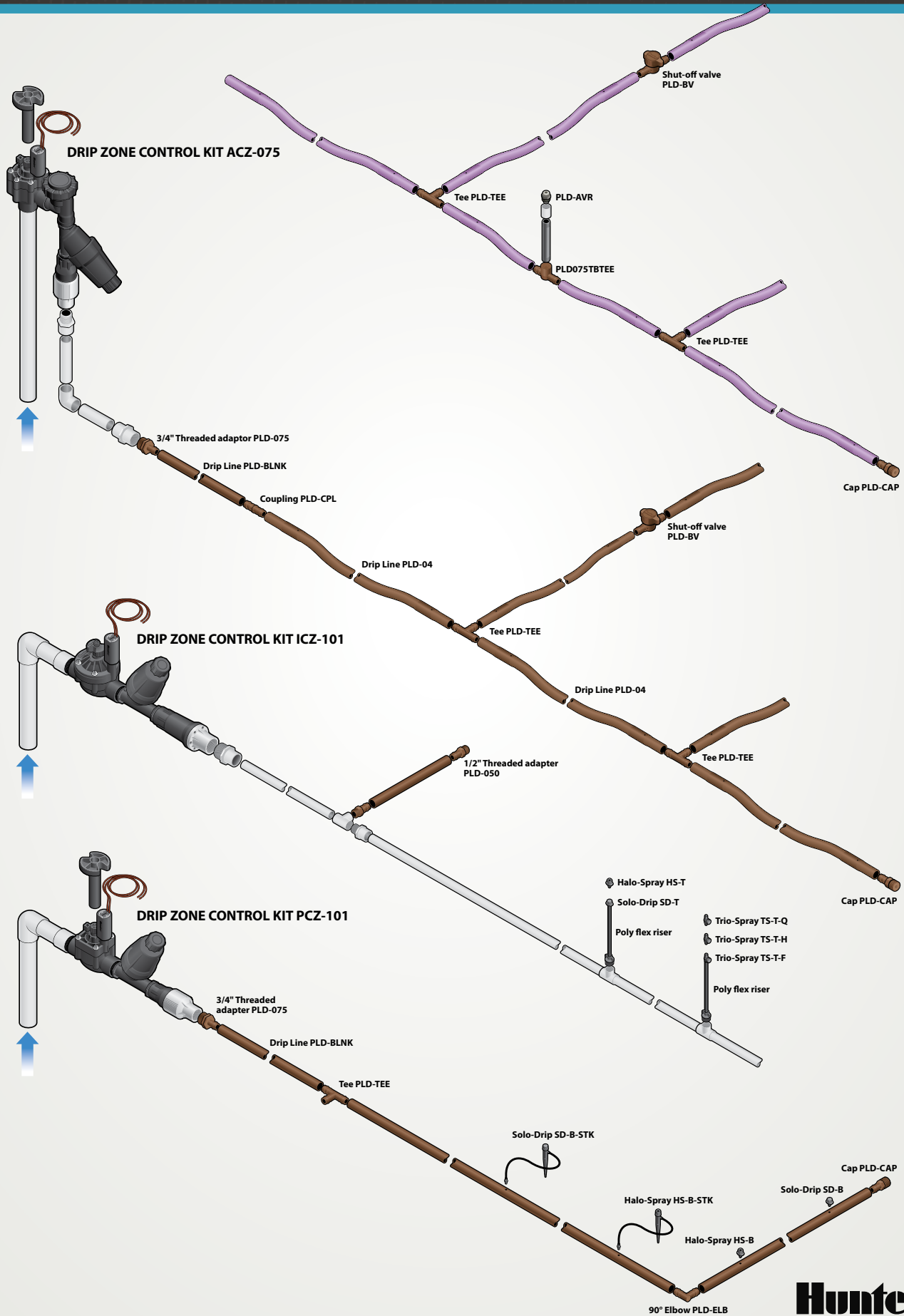

ROOT ZONE WATERING SYSTEM

APPLICATION
Residential/Commercial
Shrub and Tree Irrigation

SIZES
10", 18", 36"

FLOW RATES
0.25 or
0.50 GPM

**FOR HEALTHIER TREES AND SHRUBS,
GET TO THE ROOT OF THINGS.**

FEATURES

- Built in Hunter Swing Joint for direct installation to 1/2" PVC fitting
- Patented StrataRoot baffles divert water to root zone while adding strength to the unit
- Locking cap

DIMENSIONS

- 10": 2" diameter x 10" length
- 18": 3" diameter x 18" length
- 36": 3" diameter x 36" length

OPERATING SPECIFICATIONS

- Bubbler flow rates: 0.25 or 0.50 GPM
- Recommended pressure range: 15 to 70 PSI

FACTORY INSTALLED OPTIONS

- Check valve
- Locking reclaimed purple cap

USER INSTALLED OPTIONS

- Sleeve: Fabric sleeve that helps prevent soil intrusion in sandy soils (P/N RZWS-SLEEVE)
- Replacement cap 18" and 36" only (P/N RZWS-CAP)
- Locking reclaimed purple cap 18" and 36" only (P/N RZWS-RCCAP)



Standard and reclaimed models available

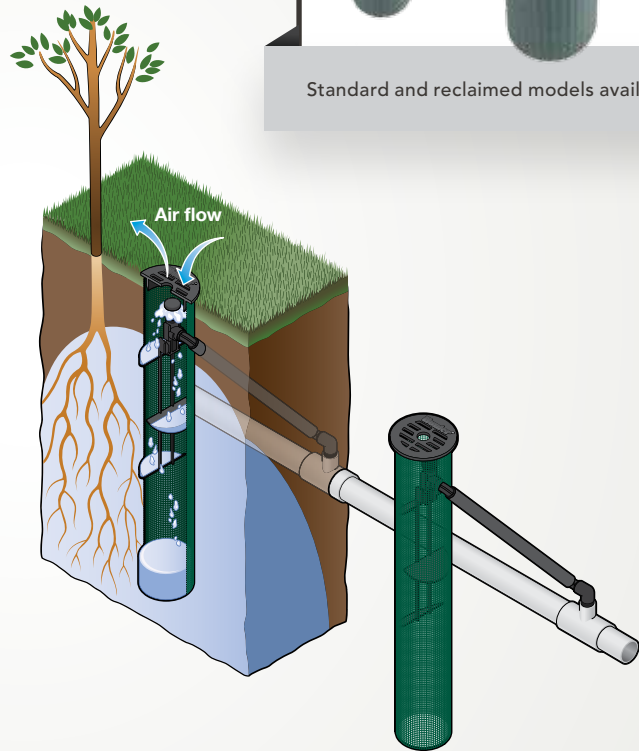

SPECIFICATIONBUILDER

www.hunterindustries.com/RZWS

MODELS	BUBBLER FLOW RATE	OPTIONS
RZWS-10 = 10" Root zone watering system	25 = 0.25 GPM	(blank) = No option
RZWS-18 = 18" Root zone watering system	50 = 0.50 GPM	CV = Check valve
RZWS-36 = 36" Root zone watering system		R = Reclaimed cap
		CV-R = Check valve with reclaimed cap

EXAMPLES

RZWS-18 - 25 - CV	18" Root zone watering system at 0.25 GPM, with check valve
RZWS-10 - 50 - R	10" Root zone watering system at 0.50 GPM, with reclaimed cap
RZWS-36 - 25 - CV	36" Root zone watering system, at 0.25 GPM, with check valve

**ADDITIONAL OPTIONS
SPECIFIED SEPARATELY**

- RZWS-SLEEVE = Field installed sleeve made from filter fabric
- RZWS-CAP = Replacement cap for 18" and 36" models
- RZWS-RCCAP = Reclaimed water replacement cap for 18" and 36" models

DRIP / MICRO

ACCESSORIES



THE DISTINCTION IS IN THE DETAILS.

Hunter manufactures a full range of convenient accessories that save both time and money. Finish the job right and maintain Hunter quality throughout all projects.

ACCESSORIES

HCV

Models

- HC-50F-50F: 1/2" Female inlet x 1/2" Female outlet
- HC-50F-50M: 1/2" Female inlet x 1/2" Male outlet
- HC-75F-75M: 3/4" Female inlet x 3/4" Male outlet

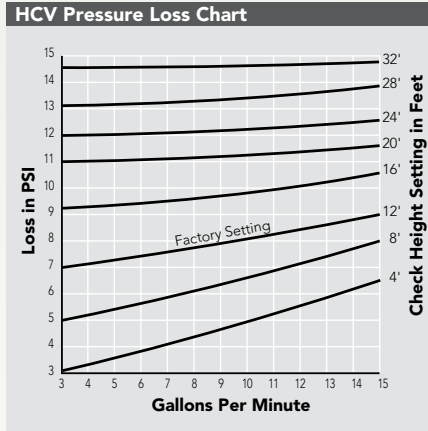

HCV: Overall height: 3"

HUNTER SPIRAL BARB ELBOWS

Models

- HSBE-050: 1/2" male NPT x spiral barb elbow
- HSBE-075: 3/4" male NPT x spiral barb elbow
- HSBE TOOL: Insert tool

Features

- For use with FLEX_{SG} Tubing and Hunter Flexible Tubing (HFT-100)
- Acetel material for sharp barbs
- Operating pressure up to 80 PSI
- Compatible with FLEX_{SG}, HFT, and other brands



Spiral Barb Elbows:
HSBE-TOOL, HSBE-050, HSBE-075

SJ SWING JOINT

Models

- SJ-506: 1/2" threaded x 6" length standard
- SJ-506-R: 1/2" threaded x 6" length retrofit
- SJ-7506: 1/2" x 3/4" threaded x 6" length
- SJ-706: 3/4" threaded x 6" length
- SJ-512: 1/2" threaded x 12" length
- SJ-7512: 1/2" x 3/4" threaded x 12" length
- SJ-712: 3/4" threaded x 12" length

Features

- Standard configuration has swivel ells on both ends for maximum versatility
- Retrofit version has a 13/16" hex nut for easy threading into horizontally oriented fittings
- Unique patented swivel ells can be installed to virtually any configuration, leak free
- Pressure rated to 150 PSI

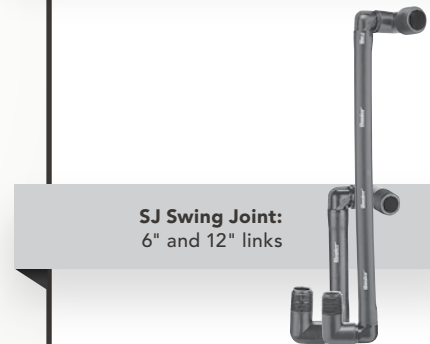
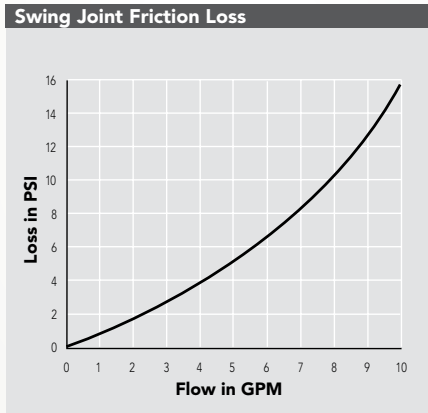

SJ Swing Joint:
6" and 12" links

HUNTER FLEXIBLE TUBING

Model

- HFT-100 – 100' roll

Features

- Inside diameter: 0.49"
- Operating pressure: up to 80 PSI
- Linear low-density polyethylene material
- Meets ASTM D2104, D2239, D2737

FLEX_{SG} TUBING

Model

- FLEX_{SG} – 100' roll

Features

- Engineered to resist kinking
- Inside diameter: 0.49"
- Operating pressure: up to 80 PSI
- Linear low-density polyethylene material
- Meets ASTM D2104, D2239, D2737



Hunter Flexible Tubing:
100' roll



FLEX_{SG} Tubing:
100' roll

ACCESSORIES



Hand Pump:
P/N 460302



Rotor Pressure Gauge:
P/N 129900
(works with PGP-ADJ)



"T" Handle Tool:
P/N 053191



Nozzle Insertion Collar:
P/N 123200



MP Gauge Assembly:
P/N MPGAUGE



**Rotor Pitot Gauge
and Tube Assembly:**
P/N 280100

REPLACEMENT GUIDE

Bringing together a combination of intelligent design, carefully controlled manufacturing, and regular testing to ensure conformity to the strictest standards, Hunter has been able to create what performance studies have shown to be truly exceptional nozzles. Essentially, we have made the science of developing superior nozzles—and thus, superior sprinklers—look easy. In the process, we have also made it easy for you to determine exactly which of these high performance sprinklers make the appropriate choice for you to install as an alternative to your current product that does not carry the Hunter label. Simply consult our comprehensive replacement guide and you'll quickly see there's a better quality, better performing sprinkler from Hunter that will fit whatever irrigation need you have.

PGJ Gear Driven Rotary Sprinklers

TO REPLACE		USE HUNTER NOZZLE	
RAIN BIRD®			
		RED	
3500	0.75	.75	
	1	1.0	
	1.5	1.5	
	2	2.0	
	3	3.0	
	4	4	
T-Bird T-22	.65 (Blue)	.75	
	1.0 (Red)	1.0	
	1.3 (Black)	1.5	
	2.0 (Brown)	2.0	
	2.5 (Gray)	2.5	
	4.0 (Yellow)	4.0	
T-Bird T-30	1.0 (Red)	1.0	
	1.3 (Black)	1.5	
	2.0 (Brown)	2.0	
	2.5 (Gray)	2.5	
	4.0 (Yellow)	4.0	
	5.0 (Green)	5.0	
NELSON®			
5500	#51	.75	
	#52	1.5	
	#53	2.0	
	#54	2.5	
TORO®			
300/340	1	.75	
Stream Rotor	2	1.5	
	3	3.0	

PGP® Gear Driven Rotary Sprinklers

TO REPLACE		USE HUNTER NOZZLE		
RAIN BIRD®				
		RED	BLUE	
Mini-Paw 15103	07 (Black)	6	2.5	
	09 (Green)	7	3.0	
Maxi-Paw 2045	06 (Red)	5	2.0	
	07 (Black)	6	2.5	
	08 (Blue)	8	4.0	
	10 (Yellow)	9	5.0	
	12 (Beige)	10	8.0	
R-50	1.5 (Black)	5	2.0	
	2.0 (Brown)	7	3.0	
	3.0 (Gray)	8	4.0	
	4.0 (Yellow)	9	5.0	
	6.0 (Green)	10	8.0	
T-Bird T-30	1.3 (Black)	4	1.5	
	2.5 (Gray)	6	2.5	
	5.0 (Green)	9	5.0	
5000	1.5	4	1.5	
	2.0	5	2.0	
	3.0	7	3.0	
	4.0	8	4.0	
	6.0	9	5.0	
	8.0	10	8.0	
5505	2	5	2.0	
	3	6	2.5	
	4	7	3.0	
	5	8	4.0	
	6	9	5.0	
	8	10	8.0	
	10	10	8.0	
	12	11	8.0	
15111	10 (5/32" nozzle)	9	5.0	
21A, 27A	10 (5/32" nozzle)	9	5.0	
25	10 (5/32" nozzle)	9	5.0	
31A, 37A	14 (7/32" nozzle)	11	8.0	
35	12 (3/16" nozzle)	10	8.0	
K-RAIN				
RPS75	0.50	1	--	
	0.75	2	--	
	1.0	4	1.5	
	2.0	6	2.0	
	2.5	7	2.5	
	3.0	8	3.0	
	4.0	9	4.0	
	6.0	10	6.0	
	8.0	11	8.0	

PGP® Gear Driven Rotary Sprinklers

TO REPLACE		USE HUNTER NOZZLE		
TORO				
		RED	BLUE	
300/340	308-XX-02	4	1.5	
Stream Rotor	308-XX-03	7	3.0	
	316-XX-02	7	3.0	
	316-XX-03	10	8.0	
XP-300 Series	XP-300-090-07	4	1.5	
	180-07	7	3.0	
	360-07	10	8.0	
	XP-300-090-09	5	2.0	
	180-09	8	4.0	
	360-09	11	--	
	XP-300-090-10	5	2.0	
	180-10	9	5.0	
	360-10	12	--	
Super 600	1.3	4	1.5	
	2.5	7	3.0	
	5.0	10	8.0	
	6.0	10	8.0	
Super 700	1.3	3	1.5	
	1.5	4	1.5	
	2.0	5	2.0	
	3.0	7	3.0	
	4.5	8	4.0	
	6.0	9	5.0	
	7.5	10	8.0	
	9.0	11	8.0	
Super 800	0.50	1	--	
	0.75	2	--	
	1.0	4	1.5	
	2.0	6	2.0	
	2.5	7	2.5	
	3.0	8	3.0	
	4.0	9	4.0	
	6.0	10	6.0	
	8.0	11	8.0	
TR50	1.0	3	--	
	1.5	4	1.5	
	2.0	5	2.0	
	3.0	6	3.0	
	4.5	8	4.0	
	6.0	9	6.0	
	7.5	10	8.0	
	9.0	11	8.0	

REPLACEMENT GUIDE

PGP Ultra/I-20 Gear Driven Rotary Sprinklers

TO REPLACE	USE HUNTER NOZZLE	
RAIN BIRD®		
		BLUE
Mini-Paw 15103	07 (Black)	2.5
	09 (Green)	3.0
Maxi-Paw 2045	06 (Red)	2.0
	07 (Black)	2.5
	08 (Blue)	4.0
	10 (Yellow)	5.0
	12 (Beige)	8.0
R-50	1.5 (Black)	2.0
	2.0 (Brown)	3.0
	3.0 (Gray)	4.0
	4.0 (Yellow)	5.0
	6.0 (Green)	8.0
T-Bird T-30	1.3 (Black)	1.5
	2.5 (Gray)	2.5
	5.0 (Green)	5.0
5000	1.5	1.5
	2.0	2.0
	3.0	3.0
	4.0	4.0
	6.0	5.0
	8.0	8.0
5505	2	2.0
	3	2.5
	4	3.0
	5	4.0
	6	5.0
	8	8.0
	10	8.0
	12	8.0
15111	10 (5/32" nozzle)	5.0
21A, 27A	10 (5/32" nozzle)	5.0
25	10 (5/32" nozzle)	5.0
31A, 37A	14 (7/32" nozzle)	8.0
35	12 (3/16" nozzle)	8.0
K-RAIN		
		BLUE
RPS75	0.50	--
	0.75	--
	1.0	1.5
	2.0	2.0
	2.5	2.5
	3.0	3.0
	4.0	4.0
	6.0	6.0
	8.0	8.0

PGP Ultra/I-20 Gear Driven Rotary Sprinklers

TO REPLACE	USE HUNTER NOZZLE	
TORO		
		BLUE
300 / 340	308-XX-02	1.5
Stream Rotor	308-XX-03	3.0
	316-XX-02	3.0
	316-XX-03	8.0
XP-300 Series	XP-300-090-07	1.5
	180-07	3.0
	360-07	8.0
	XP-300-090-09	2.0
	180-09	4.0
	360-09	--
	XP-300-090-10	2.0
	180-10	5.0
	360-10	--
Super 600	1.3	1.5
	2.5	3.0
	5.0	8.0
	6.0	8.0
Super 700	1.3	1.5
	1.5	1.5
	2.0	2.0
	3.0	3.0
	4.5	4.0
	6.0	5.0
	7.5	8.0
	9.0	8.0
Super 800	0.50	--
	0.75	--
	1.0	1.5
	2.0	2.0
	2.5	2.5
	3.0	3.0
	4.0	4.0
	6.0	6.0
	8.0	8.0
TR50	1.0	--
	1.5	1.5
	2.0	2.0
	3.0	3.0
	4.5	4.0
	6.0	6.0
	7.5	8.0
	9.0	8.0

Spray Sprinklers

TO REPLACE	USE HUNTER PRODUCT	
ALL MANUFACTURERS NOZZLES		
		NOZZLES
Nozzles	8' Radius	8A
	10' Radius	10A
	12' Radius	12A
	15' Radius	15A
	17' Radius	17A
Rain Bird 1800		PRO-SPRAY
1800 SAM		PRO-SPRAY-CV
1800 SAM PRS		PRO-SPRAY-PRS30-CV
Uni-Spray		PS ULTRA

REPLACEMENT GUIDE

I-25 Gear Driven Rotary Sprinklers

TO REPLACE		USE HUNTER NOZZLE
RAIN BIRD®		
FALCON	4 (Black)	4 (YELLOW)
	6 (Lt. Blue)	5 (WHITE)
	8 (Dk. Green)	7 (ORANGE)
	10 (Gray)	8 (LT. BROWN)
	12 (Beige)	10 (LT. GREEN)
	14 (Lt. Green)	13 (LT. BLUE)
	16 (Dk. Brown)	18 (RED)
	18 (Dk. Blue)	20 (DK. BROWN)
41-51A	18 x 11.5	20 (DK. BROWN)
41-51A	13 x 11	13 (LT. BLUE)
47A	16	13 (LT. BLUE)
37A	14	8 (LT. BROWN)
7005	4 (Black)	4 (YELLOW)
	6 (Lt. Blue)	5 (WHITE)
	8 (Dk. Green)	8 (LT. BROWN)
	10 (Gray)	10 (LT. GREEN)
	12 (Beige)	13 (LT. BLUE)
	14 (Lt. Green)	15 (GRAY)
	16 (Dk. Brown)	18 (RED)
	18 (Dk. Blue)	20 (DK. BROWN)
8005	12 (Beige)	13 (LT. BLUE)
	14 (Lt. Green)	15 (GRAY)
	16 (Dk. Brown)	18 (RED)
	18 (Dk. Blue)	20 (DK. BROWN)
	20 (Red)	23 (DK. GREEN)
	22 (Yellow)	25 (DK. BLUE)
	24 (Orange)	28 (BLACK)
Toro®		
2001	6 (Yellow)	7 (ORANGE)
	9 (Red)	8 (LT. BROWN)
	12 (Brown)	10 (LT. GREEN)
	18 (Blue)	18 (RED)
	24 (Green)	25 (DK. BLUE)
640	40	8 (LT. BROWN)
	41	10 (LT. GREEN)
	42	13 (LT. BLUE)
	43	15 (GRAY)
	44	20 (DK. BROWN)
NELSON®		
7000 & 7500	1	7 (ORANGE)
	2	8 (LT. BROWN)
	3	10 (LT. GREEN)
	4	13 (LT. BLUE)
	5	15 (GRAY)
	6	20 (DK. BROWN)
	7	23 (DK. GREEN)
	8	25 (DK. BLUE)
THOMPSON®		
186/187	P-Nozzle	5 (WHITE)
	Q-Nozzle	7 (ORANGE)
	R-Nozzle	13 (LT. BLUE)
	S-Nozzle	15 (GRAY)
	T-Nozzle	18 (RED)
	U-Nozzle	23 (DK. GREEN)
	VS-Nozzle	28 (BLACK)
	V-Nozzle	28 (BLACK)
	W-Nozzle	28 (BLACK)
SINGLE NOZZLE		ALL IMPACT MFRS
	5/32"	4 (YELLOW)
	11/64"	5 (WHITE)
	3/16"	7 (ORANGE)
	13/64"	8 (LT. BROWN)
	7/32"	10 (LT. GREEN)
	15/64"	13 (LT. BLUE)
	1/4"	15 (GRAY)
	17/64"	20 (DK. BROWN)

I-35 Gear Driven Rotary Sprinklers

TO REPLACE		USE HUNTER NOZZLE
TORO		
2001	9 (Red)	9 (LT. BROWN)
	18 (Blue)	18 (RED)
	24 (Green)	24 (DK. BLUE)
640	40	9 (LT. BROWN)
	42	12 (LT. BLUE)
	43	15 (GRAY)
	44	21 (DK. BROWN)
NELSON®		
7000 & 7500	2	9 (LT. BROWN)
	4	12 (LT. BLUE)
	5	15 (GRAY)
	6	21 (DK. BROWN)
	7	24 (DK. GREEN)
	8	27 (DK. BLUE)
THOMPSON®		
186/187	R-Nozzle	12 (LT. BLUE)
	S-Nozzle	15 (GRAY)
	T-Nozzle	18 (RED)
	U-Nozzle	24 (DK. GREEN)
	VS-Nozzle	30 (BLACK)
	V-Nozzle	30 (BLACK)
	W-Nozzle	30 (BLACK)
SINGLE NOZZLE		ALL IMPACT MFRS
	13/64"	9 (LT. BROWN)
	15/64"	12 (LT. BLUE)
	1/4"	15 (GRAY)
	17/64"	21 (DK. BROWN)
RAIN BIRD®		
FALCON	10 (Gray)	9 (LT. BROWN)
	14 (Lt. Green)	12 (LT. BLUE)
	16 (Dk. Brown)	18 (RED)
	18 (Dk. Blue)	21 (DK. BROWN)
41-51A	18 x 11.5	21 (DK. BROWN)
41-51A	13 x 11	12 (LT. BLUE)
47A	16	12 (LT. BLUE)
37A	14	9 (LT. BROWN)
7005	8 (Dk. Green)	9 (LT. BROWN)
	12 (Beige)	12 (LT. BLUE)
	14 (Lt. Green)	15 (GRAY)
	16 (Dk. Brown)	18 (RED)
	18 (Dk. Blue)	21 (DK. BROWN)
8005	12 (Beige)	12 (LT. BLUE)
	14 (Lt. Green)	15 (GRAY)
	16 (Dk. Brown)	18 (RED)
	18 (Dk. Blue)	21 (DK. BROWN)
	20 (Red)	24 (DK. GREEN)
	22 (Yellow)	27 (DK. BLUE)
	24 (Orange)	30 (BLACK)

REPLACEMENT GUIDE

I-40 Gear Driven Rotary Sprinklers

TO REPLACE	USE HUNTER NOZZLE	
RAIN BIRD®		
41-51A	18 x 11.5	44
41-51A	13 x 11	43
47A-SAM	16	42
37A	14	41
65 SERIES	16	42
8005	12 (Beige)	41
	14 (Lt. Green)	43
	16 (Dk. Brown)	43
	18 (Dk. Blue)	44
	20 (Red)	44
	22 (Yellow)	45
RAIN BIRD®		
TALON	14	42
	16	43
	18	44
	20	45
	22	45
THOMPSON®		
186/7	R-Nozzle	42
	S-Nozzle	43
	T-Nozzle	43
188/9	U-Nozzle	44
	V-Nozzle	45
TORO®		
640	USE HUNTER 40-44	
SINGLE NOZZLE	ALL IMPACT MFRS	
	15/64"	41
	1/4"	42
	17/64"	43
	9/32"	43

HQ-Quick Couplers

TO REPLACE	USE HUNTER HQ		
RAIN BIRD®	TORO®	BUCKNER	WEST AG/STORM
3RC	473-00, 473-01	QB3RC07	4V075-RY/QCV075-R
33DRC		QB33RC07	4V133-4A-RY/QCV133-4A-R
33DLRC, 33DNP		QB33LRC07, QB33NP07	4V133-4A-RL, QCV133-4A-RL-2, QCV133-4A-N-2
44RC	474-21	QB44RC10	4V144-RY/QCV144-R
44LRC, 44NP	474-24	QB44LRC10, QB44NP10	4V144-RLY, 4V144-RL-NP/QCV144-RL, QCV144-N
	474-21	QB44RCATAR10	
4NP-Acme	474-44	QB44LRCATAR10, QB44NPATAR10	
5RC	475-00, 475-01	QBRB5RC10	4V101-RY/QCV101-R
5LRC, 5NP	475-03, 475-04	QBRB5LRC10, QBRB5NP10	4V101-RLY, 4V101-RL-NP/QCV101-RL, QCV101-N
5RC-BSP		QBRB5RC10BS	4V101-RY-BS/QCV101-R-BS
5LRC-BSP		QBRB5LRC10BS, QBRB5NP10BS	4V101-RLY-BS, 4V101-RL-NP-BS/QCV101-RL-BS, QCV101-N-BS

HK-Keys, HS-Swivels & HLK-Locking Cover Key

TO REPLACE	USE HUNTER HK		
RAIN BIRD®	TORO®	BUCKNER	WEST AG/STORM
33K, 33DK	463-01	QB33K07	4C075/C075
44K	464-01	QB44K10	4C100/C100
4K-Acme	464-03	QB44KAT10	4C100A/C100A
55K-1	465-01	QB55K10	4C101/C101
TO REPLACE	USE HUNTER HS		
RAIN BIRD®	TORO®	BUCKNER	WEST AG/STORM
SH-0	477-00	HS075	4HS-075/HS075
SH-1	477-01	HS100	4HS-100/HS-100
SH-2	477-02	HS101	4HS-101/HS-101
		HS100BS	4HS-100-BS/HS-100-BS
		HS101BS	4HS-101-BS/HS-101-BS

PRECIPITATION RATES

A brief overview for the irrigation professional on how to calculate this important information.

In this section, the "Sprinkler Spacing Method—Any Arc and Any Spacing" equation is used to calculate precipitation rates. The first set of equations with the ■ shows the precipitation rate for the sprinklers when they are laid out in a square pattern. The next set with the ▲ shows the precipitation rate for the sprinklers laid out in an equilateral triangular spacing pattern. This is the "Sprinkler Spacing Method—Equilateral Triangular Spacing" equation.

WHAT IS "PRECIPITATION RATE"?

If someone said they were caught in a rainstorm that dropped one inch of water in an hour, you would have some idea of how "hard" or "heavily" the rain came down. A rainstorm that covers an area with one inch of water in one hour has a "precipitation rate" of one inch per hour (1 in/hr or 25 mm/hr). Similarly, the precipitation rate is the "speed" at which a sprinkler or an irrigation system applies water.

MATCHED PRECIPITATION RATES

A zone or system in which all the heads have similar precipitation rates is said to have "matched precipitation rates." Systems that have matched precipitation rates reduce wet and dry spots and excessive run times which lead to high water consumption and increased costs. Knowing that sprinkler spacing,

flow rates, and arcs of coverage affect precipitation rates, a general rule of thumb is: as the spray arc doubles, so should the flow.

■ 90° Arc = 1 GPM
(0.23 m³/hr; 3.8 l/min)

◐ 180° Arc = 2 GPM
(0.45 m³/hr; 7.6 l/min)

● 360° Arc = 4 GPM
(0.91 m³/hr; 15.1 l/min)

The flow rate of half-circle heads must be two times the flow rate of the quarter-circle heads, and the full-circle heads must have two times the flow rate of the half-circle heads. In the illustration, the same amount of water is applied to each quarter circle area and precipitation is therefore matched.

CALCULATING PRECIPITATION RATES

Depending upon the construction of the irrigation system, the precipitation rate may be calculated by either a "sprinkler spacing" or a "total area" method.

<p>Sprinkler Spacing Method The precipitation rate should be calculated for each individual zone. If all sprinkler heads on the zone have the same spacing, flow rate, and arc of coverage, use one of the following formulas:</p>	<p>Any Arc and Any Spacing (■):</p> $\text{P.R. (in/hr)} = \frac{\text{GPM (for any Arc)} \times 34,650}{\text{Degrees of Arc} \times \text{Head Spacing (ft)} \times \text{Row Spacing (ft)}}$ $\text{P.R. (mm/hr)} = \frac{\text{m}^3/\text{hr (for any Arc)} \times 360,000}{\text{Degrees of Arc} \times \text{Head Spacing (m)} \times \text{Row Spacing (m)}}$ $\text{P.R. (mm/hr)} = \frac{\text{l/min (for any Arc)} \times 21,600}{\text{Degrees of Arc} \times \text{Head Spacing (m)} \times \text{Row Spacing (m)}}$ <p>Equilateral Triangular Spacing (▲):</p> $\text{P.R. (in/hr)} = \frac{\text{GPM of 360 Arc} \times 96.25}{(\text{Head Spacing})^2 \times .866}$ $\text{P.R. (mm/hr)} = \frac{\text{m}^3/\text{hr} \times 1,000}{\text{Total Area}}$
<p>Total Area Method The precipitation rate for a "system" is the average precipitation rate of all sprinklers in an area, regardless of the spacing, flow rate, or arc for each head. The Total Area Method calculates all the flows of all of the heads in any given area.</p>	$\text{P.R. (in/hr)} = \frac{\text{Total GPM} \times 96.25}{\text{Total Area}}$ $\text{P.R. (mm/hr)} = \frac{\text{l/min} \times 60}{\text{Total Area}}$

For more information on precipitation rates, visit www.hunterindustries.com/mpbasics

TECHNICAL

SLOPE EQUIVALENTS/IRRIGATION

Percent, Angle, and Ratio

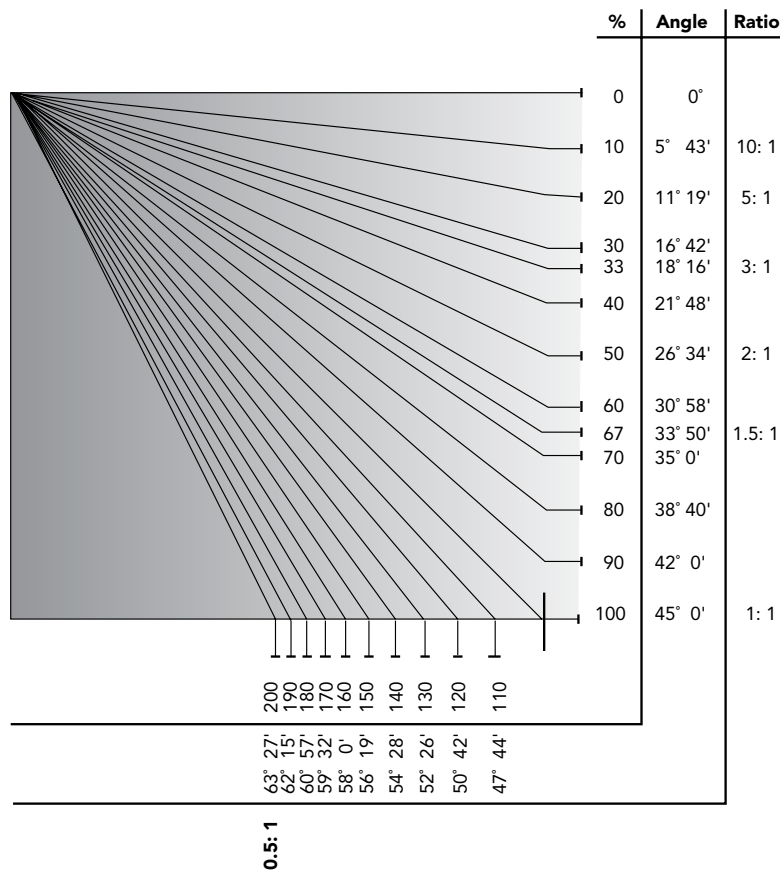

Slope Irrigation

Maximum precipitation rates for slopes.

The maximum precipitation values listed below are those suggested by the United States Department of Agriculture. The values are average and may vary with respect to actual soil condition and condition of ground cover.

SOIL TEXTURE	0 to 5% slope		5 to 8% slope		8 to 12% slope		12% + slope	
	Cover	Bare	Cover	Bare	Cover	Bare	Cover	Bare
Coarse sandy soils	2.00	2.00	2.00	1.50	1.50	1.00	1.00	0.50
Coarse sandy soils over compact subsoils	1.75	1.50	1.25	1.00	1.00	0.75	0.75	0.40
Light sandy loams uniform	1.75	1.00	1.25	0.80	1.00	0.60	0.75	0.40
Light sandy loams over compact subsoils	1.25	0.75	1.00	0.50	0.75	0.40	0.50	0.30
Uniform silt loams	1.00	0.50	0.80	0.40	0.60	0.30	0.40	0.20
Silt loams over compact subsoil	0.60	0.30	0.50	0.25	0.40	0.15	0.30	0.10
Heavy clay or clay loam	0.2	0.15	0.15	0.1	0.12	0.08	0.1	0.06

HEIGHT OF SPRAY

The trajectory and spray height of the water stream leaving a sprinkler nozzle is important information when designing and installing irrigation systems.

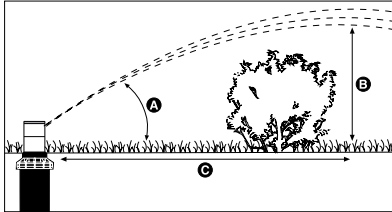

These rotor nozzle trajectory charts are designed to help determine how close a sprinkler can be placed to an object such as a fence or hedge without obstructing the spray pattern. All information shown is at optimum operating pressures.

Model	Nozzle No.	Pressure in PSI	A Degrees of Trajectory	B Max Height of Spray	C Distance from head (ft.) to Maximum Height
MP Rotator	3000	40	26	79"	Varies
	2000	40	26	45"	Varies
	1000	40	20	20"	Varies
	Corner	40	14	14"	Varies
	Side Strip	40	16	19"	Varies
	Left Strip	40	16	18"	Varies
PGJ	.75	40	10	2'	4'
	1.0	40	10	2'	8'
	1.5	40	10	3'	12'
	2.0	40	15	5'	16'
	2.5	40	12	5'	20'
	3.0	40	15	5'	20'
	4.0	40	15	5'	22'
	5.0	40	15	6'	24'
PGP® Red Nozzles	1	50	26	7'	22'
	2	50	26	7'	22'
	3	50	26	8'	23'
	4	50	26	8'	23'
	5	50	27	9'	26'
	6	50	27	10'	28'
	7	50	26	11'	30'
	8	50	26	11'	30'
	9	50	27	12'	32'
	10	60	25	13'	32'
	11	60	25	13'	38'
	12	60	25	13'	40'
PGP Low Angle Gray Nozzles	4	50	15	5'	22'
	5	50	15	4'	22'
	6	50	14	4'	22'
	7	50	14	4'	22'
	8	50	14	5'	24'
	9	50	15	5'	26'
PGP Blue Nozzles	1.5	45	25	8'	23'
	2.0	45	25	8'	23'
	2.5	45	25	9'	26'
	3.0	45	25	10'	28'
	4.0	45	25	11'	30'
	5.0	45	25	11'	30'
	6.0	55	25	12'	32'
	8.0	55	25	13'	32'
PGP Ultra/I-20 Dark Blue Nozzles	1.0	50	26	8'	23'
	1.5	50	26	8'	23'
	2.0	50	27	9'	26'
	3.0	50	27	10'	28'
	3.5	50	26	11'	30'
	4.0	50	26	11'	30'
	6.0	50	27	12'	32'
	8.0	60	25	13'	32'
PGP Ultra/I-20 Blue Nozzles	1.5	45	25	8'	23'
	2.0	45	25	8'	23'
	2.5	45	25	9'	26'
	3.0	45	25	10'	28'
	4.0	45	25	11'	30'
	5.0	45	25	11'	30'
	6.0	55	25	12'	32'
	8.0	55	25	13'	32'

HEIGHT OF SPRAY

Hunter Nozzle Height and Trajectory Chart					
Model	Nozzle No.	Pressure in PSI	A Degrees of Trajectory	B Max Height of Spray (ft.)	C Distance from head (ft.) to Maximum Height
PGP Ultra/I-20 Low Angle Gray Nozzles	2.0LA	50	13	5	22
	2.5LA	50	13	4	22
	3.5LA	50	13	4	22
	4.5LA	50	13	4	22
PGP Ultra/I-20 Short Radius Black Nozzles	.50	50	15	5	8
	1.0	50	14	6	9
	2.0	50	3	1	6
PGP Ultra/I-20 Short Radius Black Nozzles	.75	50	22	7	13
	1.5	50	18	7	13
	3.0	50	8	1	6
I-25	4	50	25	9	22
	5	50	25	11	28
	7	50	25	10	28
	8	50	25	11	28
	10	60	25	12	30
	13	60	25	13	31
	15	60	25	12	31
	18	60	25	15	34
	20	70	25	15	35
	23	70	25	16	38
25	70	25	16	38	
28	70	25	17	40	
I-35	9	50	25	11	28
	12	60	25	13	31
	15	60	25	12	31
	18	60	25	15	34
	21	70	25	15	35
	24	70	25	16	38
	27	70	25	16	38
30	70	25	17	40	
I-40	40	50	25	12	32
	41	60	25	14	32
	42	60	25	14	34
	43	60	25	15	42
	44	70	25	17	46
45	70	25	17	48	
I-60 ADS	7	60	20	10	28
	10	60	20	13	38
	13	60	20	13	38
	15	60	20	14	40
	18	60	20	14	40
20	60	20	15	46	
I-60 36S	7	60	20	13	36
	10	60	20	14	40
	13	60	20	14	41
	15	60	20	14	42
	18	60	20	14	43
20	60	20	17	50	
I-90 ADV	33	80	22	15	42
	38	80	22	16	48
	43	80	22	16	48
	48	80	22	17	54
	53	80	22	17	56
63	80	22	18	64	
I-90 36V	33	80	22	17	46
	38	80	22	17	50
	43	80	22	17	54
	48	80	22	17	56
	53	80	22	17	58
63	80	22	18	62	

PLD CHARTS

APPLICATION RATES

Emitter Flow Rate – 1.0 GPH				Emitter Flow Rate – 0.6 GPH				Emitter Flow Rate – 0.4 GPH			
Row Spacing (in)	Emitter Spacing (in)			Row Spacing (in)	Emitter Spacing (in)			Row Spacing (in)	Emitter Spacing (in)		
	12	18	24		12	18	24		12	18	24
12	1.60	1.07	0.80	12	0.96	0.64	0.48	12	0.64	0.43	0.32
14	1.38	0.92	0.69	14	0.83	0.55	0.41	14	0.55	0.37	0.28
16	1.20	0.80	0.60	16	0.72	0.48	0.36	16	0.48	0.32	0.24
18	1.07	0.71	0.53	18	0.64	0.43	0.32	18	0.43	0.29	0.21
20	0.96	0.64	0.48	20	0.58	0.39	0.29	20	0.39	0.26	0.19
24	0.80	0.53	0.40	24	0.48	0.32	0.24	24	0.32	0.21	0.16

PLD application rates in inches per hour

EMITTER LINE LENGTH CHARTS

Emitter Line Length – 1.0 GPH					Emitter Line Length – 0.6 GPH					Emitter Line Length – 0.4 GPH				
Pressure (PSI)	Slope %	Emitter Spacing (in)			Pressure (PSI)	Slope %	Emitter Spacing (in)			Pressure (PSI)	Slope %	Emitter Spacing (in)		
		12	18	24			12	18	24			12	18	24
15	0	126	176	222	15	0	173	240	300	15	0	289	401	502
	2	139	198	251		2	190	276	355		2	322	467	598
	4	146	214	276		4	206	306	397		4	347	517	670
20	0	169	235	295	20	0	230	320	402	20	0	354	494	620
	2	175	252	321		2	243	349	445		2	381	550	703
	4	185	268	344		4	256	374	481		4	407	597	769
25	0	197	276	346	25	0	265	373	471	25	0	405	563	706
	2	204	290	367		2	283	404	513		2	432	616	783
	4	214	304	385		4	291	424	544		4	453	661	849
30	0	218	308	390	30	0	299	417	523	30	0	441	621	783
	2	232	327	413		2	307	439	558		2	467	671	854
	4	226	335	432		4	325	469	598		4	490	712	912
35	0	240	337	425	35	0	333	462	580	35	0	481	671	842
	2	240	344	438		2	336	479	609		2	507	717	908
	4	253	361	457		4	349	499	635		4	520	756	970
40	0	263	362	452	40	0	342	483	611	40	0	508	719	910
	2	270	376	472		2	364	513	647		2	534	763	970
	4	264	383	491		4	365	530	680		4	554	799	1020
45	0	271	384	486	45	0	364	518	657	45	0	542	755	949
	2	277	397	506		2	377	535	678		2	553	797	1017
	4	281	401	510		4	387	557	711		4	573	830	1062
50	0	288	401	503	50	0	387	543	685	50	0	558	784	988
	2	294	414	522		2	400	567	717		2	581	831	1057
	4	298	424	539		4	410	580	733		4	601	870	1113

Maximum recommended PLD length on flat terrain, 2%, and 4% downhill slope.

DRIP ZONE CONTROL KIT CHARTS

ICZ101, PCZ101, ACZ075

Inlet pressure required for designed outlet pressure

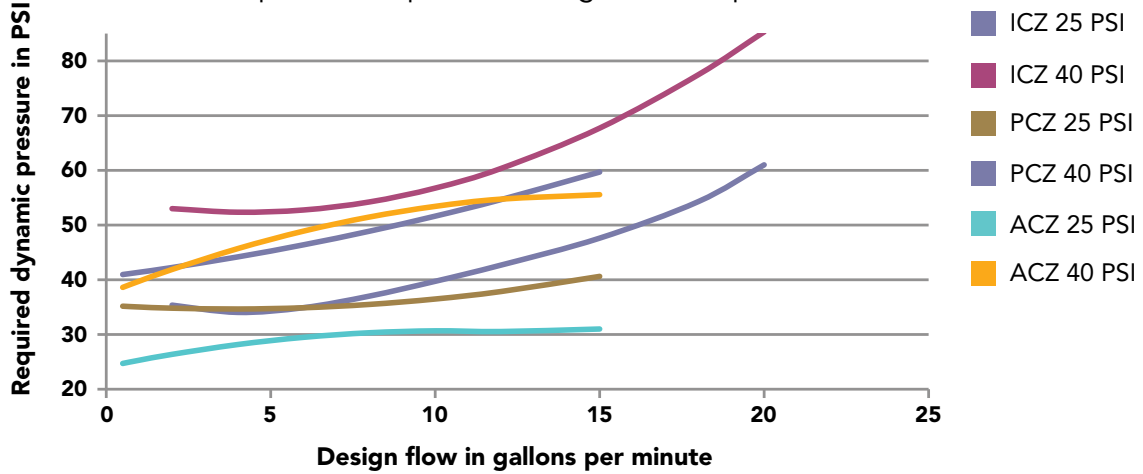

ICZ151

Inlet pressure required for designed outlet pressure

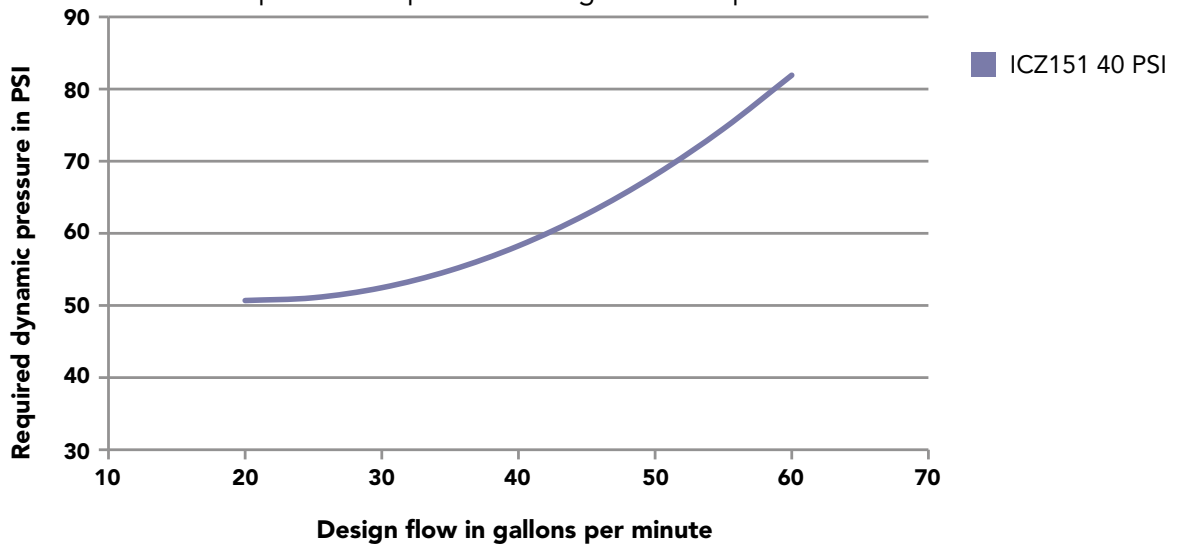

CONVERSION FACTORS

To Convert	From	To	Multiply By
AREA	acres	foot ²	43560
	acres	meter ²	4046.8
	meter ²	foot ²	10.764
	foot ²	inch ²	144
	inch ²	centimeter ²	6.452
	hectares	meter ²	10000
	hectares	acres	2.471
POWER	kilowatts	horsepower	1.341
FLOW	foot ³ /minute	meter ³ /second	0.0004719
	foot ³ /second	meter ³ /second	0.02832
	yards ³ /minute	meter ³ /second	0.01274
	gallon/minute	meter ³ /hour	0.22716
	gallon/minute	liter/minute	3.7854
	gallon/minute	liter/second	0.06309
	meter ³ /hour	liter/minute	16.645
	meter ³ /hour	liter/second	0.2774
	liter/minute	liter/second	60
LENGTH	foot	inch	12
	inch	centimeter	2.540
	foot	meter	0.30481
	kilometer	miles	0.6214
	miles	foot	5280
	miles	meter	1609.34
	millimeter	inch	0.03937
PRESSURE	PSI	kilopascals	6.89476
	PSI	bar	0.068948
	bar	kilopascals	100
	PSI	feet of head	2.31
VELOCITY	feet/second	meter/second	0.3048
VOLUME	feet ³	gallon	7.481
	feet ³	liter	28.32
	meter ³	feet ³	35.31
	meter ³	yard ³	1.3087
	yard ³	feet ³	27
	yard ³	gallon	202
	acres/feet	foot ³	43,560
	gallon	meter ³	0.003785
	gallon	liter	3.785
	imperial gallon	gallon	1.833

TECHNICAL

PRESSURE LOSS CHART

WATER METER PRESSURE LOSS CHART TYPICAL PRESSURE LOSSES (PSI)

Flow GPM	Nominal Size						Flow GPM	
	5/8"	3/4"	1"	1-1/2"	2"	3"		4"
1	0.2	0.1						1
2	0.3	0.2						2
3	0.4	0.3						3
4	0.6	0.5	0.1					4
5	0.9	0.6	0.2					5
6	1.3	0.7	0.3					6
7	1.8	0.8	0.4					7
8	2.3	1.0	0.5					8
9	3.0	1.3	0.6					9
10	3.7	1.6	0.7					10
11	4.4	1.9	0.8					11
12	5.1	2.2	0.9					12
13	6.1	2.6	1.0					13
14	7.2	3.1	1.1					14
15	8.3	3.6	1.2					15
16	9.4	4.1	1.4	0.4				16
17	10.7	4.6	1.6	0.5				17
18	12.0	5.2	1.8	0.6				18
19	13.4	5.8	2.0	0.7				19
20	15.0	6.5	2.2	0.8				20
22		7.9	2.8	1.0				22
24		9.5	3.4	1.2				24
26		11.2	4.0	1.4				26
28		13.0	4.6	1.6				28
30		15.0	5.3	1.8	0.7			30
32			6.0	2.1	0.8			32
34			6.9	2.4	0.9			34
36			7.8	2.7	1.0			36
38			8.7	3.0	1.2			38
40			9.6	3.3	1.3			40
42			10.6	3.6	1.4			42
44			11.7	3.9	1.5			44
46			12.8	4.2	1.6			46
48			13.9	4.5	1.7			48
50			15.0	4.9	1.9			50
52				5.3	2.1			52
54				5.7	2.2			54
56				6.2	2.3			56
58				6.7	2.5			58
60				7.2	2.7	1.0		60
65				8.3	3.2	1.1		65
70				9.8	3.7	1.3		70
75				11.3	4.3	1.5		75
80				12.8	4.9	1.6	0.7	80
90				16.1	6.2	2.0	0.8	90
100				20.0	7.8	2.5	0.9	100
110					9.5	2.9	1.0	110
120					11.3	3.4	1.2	120
130					13.0	3.9	1.4	130
140					15.1	4.5	1.6	140
150					17.3	5.1	1.8	150
160					20.0	5.8	2.1	160
170						6.5	2.4	170
180						7.2	2.7	180
190						8.0	3.0	190
200						9.0	3.2	200
220						11.0	3.9	220
240						13.0	4.7	240
260						15.0	5.5	260
280						17.3	6.3	280
300						20.0	7.2	300
350							10.0	350
400							13.0	400
450							16.2	450
500							20.0	500
	Shaded areas represent velocities over 5 fps. Use with caution where water hammer is a concern.							
75% of Max Meter Capacity	15 GPM	22.5 GPM	37.5 GPM	75 GPM	120 GPM	225 GPM	375 GPM	75% of Max Meter Capacity

FRICION LOSS CHARTS

Irrigation Association Friction Loss Chart 2008

TYPE K COPPER TUBING

ASTM B 88 C=140 • PSI LOSS PER 100 FEET OF PIPE

Nominal Size Pipe ID Pipe OD Avg. Wall	1/2"		5/8"		3/4"		1"		1-1/4"		1-1/2"		2"		2-1/2"		3"	
	Velocity FPS	PSI LOSS	Velocity FPS	PSI LOSS	Velocity FPS	PSI LOSS	Velocity FPS	PSI LOSS	Velocity FPS	PSI LOSS	Velocity FPS	PSI LOSS	Velocity FPS	PSI LOSS	Velocity FPS	PSI LOSS	Velocity FPS	PSI LOSS
1	1.47	1.09	0.96	0.39	0.74	0.20	0.41	0.05	0.26	0.02								
2	2.94	3.94	1.92	1.40	1.47	0.73	0.82	0.18	0.53	0.06								
3	4.41	8.35	2.88	2.97	2.21	1.55	1.24	0.38	0.79	0.13								
4	5.88	14.23	3.84	5.05	2.94	2.64	1.65	0.65	1.05	0.22								
5	7.35	21.51	4.80	7.64	3.68	3.99	2.06	0.98	1.32	0.33								
6	8.81	30.15	5.76	10.70	4.41	5.59	2.47	1.37	1.58	0.46	1.12	0.20						
7	10.28	40.12	6.72	14.24	5.15	7.44	2.88	1.82	1.84	0.61	1.30	0.26						
8	11.75	51.37	7.68	18.24	5.88	9.53	3.30	2.33	2.11	0.78	1.49	0.34						
9	13.22	63.90	8.64	22.68	6.62	11.85	3.71	2.90	2.37	0.97	1.67	0.42						
10	14.69	77.66	9.60	27.57	7.35	14.41	4.12	3.52	2.63	1.18	1.86	0.51						
12			11.52	38.64	8.82	20.20	4.95	4.94	3.16	1.66	2.23	0.71	1.28	0.18				
14			13.44	51.41	10.29	26.87	5.77	6.57	3.69	2.21	2.60	0.95	1.49	0.24				
16			15.36	65.83	11.76	34.41	6.59	8.42	4.21	2.83	2.98	1.22	1.70	0.31				
18			17.28	81.88	13.23	42.80	7.42	10.47	4.74	3.52	3.35	1.51	1.91	0.39				
20					14.70	52.02	8.24	12.72	5.26	4.28	3.72	1.84	2.13	0.47				
22					16.17	62.06	9.07	15.18	5.79	5.10	4.09	2.19	2.34	0.56	1.51	0.19	1.06	0.08
24					17.64	72.91	9.89	17.84	6.32	5.99	4.46	2.58	2.55	0.66	1.65	0.23	1.16	0.10
26							10.71	20.69	6.84	6.95	4.84	2.99	2.76	0.77	1.79	0.27	1.26	0.11
28							11.54	23.73	7.37	7.97	5.21	3.43	2.98	0.88	1.93	0.30	1.35	0.13
30							12.36	26.96	7.90	9.06	5.58	3.89	3.19	1.00	2.06	0.35	1.45	0.15
32							13.19	30.39	8.42	10.21	5.95	4.39	3.40	1.12	2.20	0.39	1.54	0.16
34							14.01	34.00	8.95	11.42	6.32	4.91	3.61	1.26	2.34	0.44	1.64	0.18
36							14.84	37.79	9.48	12.70	6.70	5.46	3.83	1.40	2.48	0.49	1.74	0.20
38							15.66	41.77	10.00	14.04	7.07	6.03	4.04	1.55	2.61	0.54	1.83	0.23
40							16.48	45.94	10.53	15.43	7.44	6.63	4.25	1.70	2.75	0.59	1.93	0.25
42							17.31	50.28	11.06	16.89	7.81	7.26	4.47	1.86	2.89	0.65	2.03	0.27
44									11.58	18.41	8.18	7.91	4.68	2.03	3.03	0.70	2.12	0.30
46									12.11	19.99	8.56	8.59	4.89	2.20	3.17	0.76	2.22	0.32
48									12.63	21.63	8.93	9.30	5.10	2.38	3.30	0.83	2.32	0.35
50									13.16	23.33	9.30	10.03	5.32	2.57	3.44	0.89	2.41	0.38
55									14.48	27.84	10.23	11.96	5.85	3.07	3.78	1.06	2.66	0.45
60									15.79	32.70	11.16	14.05	6.38	3.60	4.13	1.25	2.90	0.53
65									17.11	37.93	12.09	16.30	6.91	4.18	4.47	1.45	3.14	0.61
70									18.43	43.51	13.02	18.70	7.44	4.79	4.82	1.66	3.38	0.70
75											13.95	21.24	7.97	5.45	5.16	1.89	3.62	0.80
80											14.88	23.94	8.51	6.14	5.50	2.13	3.86	0.90
85											15.81	26.79	9.04	6.87	5.85	2.38	4.10	1.01
90											16.74	29.78	9.57	7.63	6.19	2.65	4.35	1.12
95											17.67	32.91	10.10	8.44	6.54	2.93	4.59	1.24
100											18.60	36.19	10.63	9.28	6.88	3.22	4.83	1.36
110													11.69	11.07	7.57	3.84	5.31	1.62
120													12.76	13.01	8.26	4.51	5.79	1.91
130													13.82	15.08	8.95	5.23	6.28	2.21
140													14.88	17.30	9.63	6.00	6.76	2.54
150													15.95	19.66	10.32	6.82	7.24	2.88
160													17.01	22.16	11.01	7.69	7.72	3.25
170													18.07	24.79	11.70	8.60	8.21	3.63
180														12.39	9.56	8.69	4.04	
190														13.07	10.57	9.17	4.46	
200														13.76	11.62	9.66	4.91	
220														15.14	13.87	10.62	5.86	
240														16.51	16.29	11.59	6.88	
260														17.89	18.90	12.55	7.98	
280														19.27	21.68	13.52	9.15	
300																14.48	10.40	
320																15.45	11.72	
340																16.42	13.11	
360																17.38	14.58	
380																18.35	16.11	
400																		
420																		
440																		
460																		
480																		
500																		

Shaded area represents velocities over 7 fps.
Use with caution where water hammer is a concern.

TECHNICAL

FRICION LOSS CHARTS

Irrigation Association Friction Loss Chart 2008

TYPE L COPPER TUBING

C=140 • PSI LOSS 100 FEET OF PIPE

Nominal Size Pipe ID Pipe OD Avg. Wall	1/2"		5/8"		3/4"		1"		1-1/4"		1-1/2"		2"		2-1/2"		3"	
	Velocity FPS	PSI LOSS	Velocity FPS	PSI LOSS	Velocity FPS	PSI LOSS	Velocity FPS	PSI LOSS	Velocity FPS	PSI LOSS	Velocity FPS	PSI LOSS	Velocity FPS	PSI LOSS	Velocity FPS	PSI LOSS	Velocity FPS	PSI LOSS
1	1.37	0.93	0.92	0.35	0.66	0.16	0.39	0.04	0.25	0.02								
2	2.75	3.35	1.84	1.26	1.32	0.57	0.78	0.15	0.51	0.06								
3	4.12	7.09	2.76	2.67	1.99	1.20	1.17	0.33	0.76	0.12								
4	5.49	12.09	3.68	4.56	2.65	2.05	1.55	0.56	1.02	0.20								
5	6.87	18.27	4.60	6.89	3.31	3.09	1.94	0.85	1.27	0.30								
6	8.24	25.61	5.52	9.65	3.97	4.34	2.33	1.18	1.53	0.43	1.08	0.18						
7	9.62	34.07	6.44	12.84	4.63	5.77	2.72	1.58	1.78	0.57	1.26	0.24						
8	10.99	43.63	7.36	16.45	5.30	7.39	3.11	2.02	2.04	0.72	1.44	0.31						
9	12.36	54.26	8.28	20.45	5.96	9.19	3.50	2.51	2.29	0.90	1.62	0.39						
10	13.74	65.95	9.20	24.86	6.62	11.17	3.88	3.05	2.55	1.10	1.80	0.47						
12			11.04	34.85	7.95	15.66	4.66	4.28	3.06	1.54	2.16	0.66	1.24	0.17				
14			12.88	46.36	9.27	20.83	5.44	5.69	3.57	2.04	2.52	0.88	1.45	0.23				
16			14.72	59.37	10.59	26.68	6.21	7.28	4.08	2.62	2.88	1.12	1.66	0.29				
18			16.56	73.84	11.92	33.18	6.99	9.06	4.59	3.25	3.24	1.40	1.86	0.36				
20					13.24	40.33	7.77	11.01	5.10	3.96	3.60	1.70	2.07	0.44				
22					14.57	48.11	8.54	13.14	5.61	4.72	3.96	2.03	2.28	0.53	1.48	0.18	1.03	0.08
24					15.89	56.53	9.32	15.44	6.12	5.55	4.32	2.38	2.49	0.62	1.61	0.22	1.13	0.09
26							10.10	17.90	6.63	6.43	4.68	2.76	2.69	0.72	1.75	0.25	1.22	0.11
28							10.87	20.54	7.14	7.38	5.04	3.17	2.90	0.82	1.88	0.29	1.32	0.12
30							11.65	23.33	7.65	8.38	5.40	3.60	3.11	0.94	2.01	0.33	1.41	0.14
32							12.43	26.30	8.16	9.45	5.76	4.06	3.31	1.05	2.15	0.37	1.51	0.15
34							13.20	29.42	8.67	10.57	6.12	4.54	3.52	1.18	2.28	0.41	1.60	0.17
36							13.98	32.71	9.18	11.75	6.48	5.05	3.73	1.31	2.42	0.46	1.69	0.19
38							14.76	36.15	9.69	12.99	6.84	5.58	3.93	1.45	2.55	0.51	1.79	0.21
40							15.53	39.75	10.20	14.28	7.21	6.13	4.14	1.59	2.69	0.56	1.88	0.23
42							16.31	43.51	10.71	15.63	7.57	6.71	4.35	1.75	2.82	0.61	1.98	0.26
44									11.22	17.04	7.93	7.32	4.56	1.90	2.95	0.66	2.07	0.28
46									11.73	18.50	8.29	7.94	4.76	2.07	3.09	0.72	2.16	0.30
48									12.24	20.02	8.65	8.60	4.97	2.24	3.22	0.78	2.26	0.33
50									12.75	21.59	9.01	9.27	5.18	2.41	3.36	0.84	2.35	0.35
55									14.02	25.76	9.91	11.06	5.70	2.88	3.69	1.00	2.59	0.42
60									15.30	30.26	10.81	13.00	6.21	3.38	4.03	1.18	2.82	0.50
65									16.57	35.10	11.71	15.07	6.73	3.92	4.36	1.37	3.06	0.57
70									17.85	40.26	12.61	17.29	7.25	4.50	4.70	1.57	3.29	0.66
75											13.51	19.65	7.77	5.11	5.04	1.78	3.53	0.75
80											14.41	22.14	8.28	5.76	5.37	2.01	3.76	0.84
85											15.31	24.77	8.80	6.44	5.71	2.25	4.00	0.94
90											16.21	27.54	9.32	7.16	6.04	2.50	4.23	1.05
95											17.11	30.44	9.84	7.91	6.38	2.76	4.47	1.16
100											18.01	33.47	10.35	8.70	6.71	3.03	4.70	1.28
110													11.39	10.38	7.39	3.62	5.17	1.52
120													12.43	12.20	8.06	4.25	5.65	1.79
130													13.46	14.15	8.73	4.93	6.12	2.07
140													14.50	16.23	9.40	5.66	6.59	2.38
150													15.53	18.44	10.07	6.43	7.06	2.70
160													16.57	20.78	10.74	7.24	7.53	3.05
170													17.60	23.25	11.41	8.11	8.00	3.41
180															12.09	9.01	8.47	3.79
190															12.76	9.96	8.94	4.19
200															13.43	10.95	9.41	4.61
220															14.77	13.07	10.35	5.50
240															16.12	15.35	11.29	6.46
260															17.46	17.80	12.23	7.49
280															18.80	20.42	13.17	8.59
300																	14.11	9.76
320																	15.05	11.00
340																	15.99	12.31
360																	16.94	13.69
380																	17.88	15.13
400																		
420																		
440																		
460																		
480																		
500																		

Shaded area represents velocities over 7 fps.
Use with caution where water hammer is a concern.

TECHNICAL

FRICION LOSS CHARTS

Irrigation Association Friction Loss Chart 2008

CLASS 160 PVC IPS PLASTIC PIPE

ASTM D-2241 (1120,1220) SDR 26 C=150 • PSI LOSS PER 100 FEET OF PIPE

Nominal Size Pipe ID Avg. Wall Min. Wall	Shown for convenience Class 315 1/2"		Class 200 3/4"		1"		1-1/4"		1-1/2"		2"		2-1/2"		3"		4"		6"	
	Velocity FPS	PSI LOSS	Velocity FPS	PSI LOSS	Velocity FPS	PSI LOSS	Velocity FPS	PSI LOSS	Velocity FPS	PSI LOSS	Velocity FPS	PSI LOSS	Velocity FPS	PSI LOSS	Velocity FPS	PSI LOSS	Velocity FPS	PSI LOSS	Velocity FPS	PSI LOSS
1	0.84	0.25	0.49	0.07	0.30	0.02	0.18	0.01	0.14	0.00										
2	1.68	0.90	0.99	0.24	0.59	0.07	0.36	0.02	0.27	0.01	0.17	0.00								
3	2.53	1.90	1.48	0.52	0.89	0.15	0.54	0.04	0.41	0.02	0.26	0.01								
4	3.37	3.24	1.97	0.88	1.18	0.25	0.71	0.07	0.54	0.04	0.35	0.01	0.24	0.00						
5	4.21	4.89	2.46	1.33	1.48	0.38	0.89	0.11	0.68	0.06	0.43	0.02	0.29	0.01						
6	5.05	6.86	2.96	1.86	1.77	0.54	1.07	0.16	0.81	0.08	0.52	0.03	0.35	0.01	0.24	0.00				
7	5.90	9.12	3.45	2.47	2.07	0.71	1.25	0.21	0.95	0.11	0.60	0.04	0.41	0.01	0.28	0.01				
8	6.74	11.68	3.94	3.17	2.36	0.91	1.43	0.27	1.09	0.14	0.69	0.05	0.47	0.02	0.32	0.01				
9	7.58	14.53	4.43	3.94	2.66	1.14	1.61	0.33	1.22	0.17	0.78	0.06	0.53	0.02	0.36	0.01				
10	8.42	17.66	4.93	4.79	2.96	1.38	1.78	0.40	1.36	0.21	0.86	0.07	0.59	0.03	0.40	0.01				
12	10.11	24.75	5.91	6.71	3.55	1.94	2.14	0.57	1.63	0.29	1.04	0.10	0.71	0.04	0.48	0.01				
14	11.79	32.93	6.90	8.93	4.14	2.58	2.50	0.76	1.90	0.39	1.21	0.13	0.82	0.05	0.55	0.02				
16	13.48	42.16	7.88	11.44	4.73	3.30	2.86	0.97	2.17	0.50	1.38	0.17	0.94	0.06	0.63	0.02	0.38	0.01		
18	15.16	52.44	8.87	14.23	5.32	4.10	3.21	1.20	2.44	0.62	1.56	0.21	1.06	0.08	0.71	0.03	0.43	0.01		
20			9.85	17.29	5.91	4.99	3.57	1.46	2.71	0.75	1.73	0.25	1.18	0.10	0.79	0.04	0.48	0.01		
22			10.84	20.63	6.50	5.95	3.93	1.74	2.99	0.90	1.90	0.30	1.29	0.12	0.87	0.04	0.53	0.01		
24			11.82	24.24	7.09	6.99	4.28	2.05	3.26	1.05	2.07	0.35	1.41	0.14	0.95	0.05	0.57	0.02		
26			12.81	28.11	7.68	8.11	4.64	2.38	3.53	1.22	2.25	0.41	1.53	0.16	1.03	0.06	0.62	0.02		
28			13.80	32.25	8.27	9.30	5.00	2.73	3.80	1.40	2.42	0.47	1.65	0.18	1.11	0.07	0.67	0.02		
30			14.78	36.64	8.87	10.57	5.35	3.10	4.07	1.59	2.59	0.53	1.76	0.21	1.19	0.08	0.72	0.02		
32					9.46	11.91	5.71	3.49	4.34	1.79	2.76	0.60	1.88	0.23	1.27	0.09	0.76	0.03	0.35	0.00
34					10.05	13.32	6.07	3.91	4.61	2.01	2.94	0.67	2.00	0.26	1.35	0.10	0.81	0.03	0.37	0.00
36					10.64	14.81	6.42	4.34	4.88	2.23	3.11	0.74	2.12	0.29	1.43	0.11	0.86	0.03	0.40	0.00
38					11.23	16.37	6.78	4.80	5.16	2.46	3.28	0.82	2.23	0.32	1.50	0.12	0.91	0.04	0.42	0.01
40					11.82	18.00	7.14	5.28	5.43	2.71	3.46	0.90	2.35	0.35	1.58	0.14	0.95	0.04	0.44	0.01
42					12.41	19.70	7.50	5.78	5.70	2.97	3.63	0.99	2.47	0.39	1.66	0.15	1.00	0.04	0.46	0.01
44					13.00	21.47	7.85	6.30	5.97	3.23	3.80	1.08	2.59	0.42	1.74	0.16	1.05	0.05	0.48	0.01
46					13.59	23.32	8.21	6.84	6.24	3.51	3.97	1.17	2.70	0.46	1.82	0.18	1.10	0.05	0.51	0.01
48					14.18	25.23	8.57	7.40	6.51	3.80	4.15	1.27	2.82	0.50	1.90	0.19	1.15	0.06	0.53	0.01
50					14.78	27.21	8.92	7.98	6.78	4.10	4.32	1.37	2.94	0.53	1.98	0.20	1.19	0.06	0.55	0.01
55							9.82	9.52	7.46	4.89	4.75	1.63	3.23	0.64	2.18	0.24	1.31	0.07	0.61	0.01
60							10.71	11.18	8.14	5.74	5.18	1.91	3.53	0.75	2.38	0.29	1.43	0.08	0.66	0.01
65							11.60	12.97	8.82	6.66	5.62	2.22	3.82	0.87	2.57	0.33	1.55	0.10	0.72	0.01
70							12.49	14.88	9.50	7.64	6.05	2.55	4.11	1.00	2.77	0.38	1.67	0.11	0.77	0.02
75							13.38	16.90	10.18	8.68	6.48	2.89	4.41	1.13	2.97	0.43	1.79	0.13	0.83	0.02
80							14.28	19.05	10.86	9.78	6.91	3.26	4.70	1.28	3.17	0.49	1.91	0.14	0.88	0.02
85									11.53	10.94	7.34	3.65	4.99	1.43	3.37	0.55	2.03	0.16	0.94	0.02
90									12.21	12.16	7.78	4.06	5.29	1.59	3.56	0.61	2.15	0.18	0.99	0.03
95									12.89	13.45	8.21	4.48	5.58	1.76	3.76	0.67	2.27	0.20	1.05	0.03
100									13.57	14.79	8.64	4.93	5.88	1.93	3.96	0.74	2.39	0.22	1.10	0.03
110									14.93	17.64	9.50	5.88	6.46	2.30	4.36	0.88	2.63	0.26	1.21	0.04
120											10.37	6.91	7.05	2.71	4.75	1.04	2.86	0.30	1.32	0.05
130											11.23	8.02	7.64	3.14	5.15	1.20	3.10	0.35	1.43	0.05
140											12.10	9.20	8.23	3.60	5.54	1.38	3.34	0.40	1.54	0.06
150											12.96	10.45	8.81	4.09	5.94	1.57	3.58	0.46	1.65	0.07
160											13.82	11.77	9.40	4.61	6.34	1.76	3.82	0.52	1.76	0.08
170											14.69	13.17	9.99	5.16	6.73	1.97	4.06	0.58	1.87	0.09
180													10.58	5.73	7.13	2.19	4.30	0.64	1.98	0.10
190													11.16	6.34	7.52	2.42	4.54	0.71	2.09	0.11
200													11.75	6.97	7.92	2.67	4.77	0.78	2.20	0.12
220													12.93	8.31	8.71	3.18	5.25	0.93	2.42	0.14
240													14.10	9.77	9.50	3.74	5.73	1.09	2.65	0.17
260															10.29	4.33	6.21	1.27	2.87	0.19
280															11.09	4.97	6.68	1.45	3.09	0.22
300															11.88	5.65	7.16	1.65	3.31	0.25
320															12.67	6.37	7.64	1.86	3.53	0.28
340															13.46	7.12	8.12	2.08	3.75	0.32
360															14.25	7.92	8.59	2.31	3.97	0.35
380																	9.07	2.56	4.19	0.39
400																	9.55	2.81	4.41	0.43
420																	10.03	3.08	4.63	0.47
440																	10.50	3.35	4.85	0.51
460																	10.98	3.64	5.07	0.56
480																	11.46	3.94	5.29	0.60
500																	11.94	4.25	5.51	0.65

Shaded areas represent velocities over 5 fps.
Use with caution where water hammer is a concern.

TECHNICAL

Irrigation Association Friction Loss Chart 2008

CLASS 200 PVC IPS PLASTIC PIPE

ASTM D-2241 (1120,1220) SDR 21 C=150 • PSI LOSS PER 100 FEET OF PIPE

Nominal Size Avg. ID Pipe OD Avg. Wall Min. Wall	Class 315 1/2"		3/4"		1"		1-1/4"		1-1/2"		2"		2-1/2"		3"		4"		6"	
	Velocity FPS	PSI LOSS	Velocity FPS	PSI LOSS	Velocity FPS	PSI LOSS	Velocity FPS	PSI LOSS	Velocity FPS	PSI LOSS	Velocity FPS	PSI LOSS	Velocity FPS	PSI LOSS	Velocity FPS	PSI LOSS	Velocity FPS	PSI LOSS	Velocity FPS	PSI LOSS
1	0.84	0.25	0.49	0.07	0.30	0.02	0.19	0.01	0.14	0.00										
2	1.68	0.90	0.99	0.24	0.60	0.07	0.37	0.02	0.28	0.01	0.18	0.00								
3	2.53	1.90	1.48	0.52	0.90	0.15	0.56	0.05	0.42	0.02	0.27	0.01								
4	3.37	3.24	1.97	0.88	1.19	0.26	0.74	0.08	0.56	0.04	0.36	0.01	0.24	0.01						
5	4.21	4.89	2.46	1.33	1.49	0.39	0.93	0.12	0.71	0.06	0.45	0.02	0.31	0.01						
6	5.05	6.86	2.96	1.86	1.79	0.55	1.11	0.17	0.85	0.09	0.54	0.03	0.37	0.01	0.25	0.00				
7	5.90	9.12	3.45	2.47	2.09	0.73	1.30	0.23	0.99	0.12	0.63	0.04	0.43	0.02	0.29	0.01				
8	6.74	11.68	3.94	3.17	2.39	0.94	1.49	0.30	1.13	0.15	0.72	0.05	0.49	0.02	0.33	0.01				
9	7.58	14.53	4.43	3.94	2.69	1.17	1.67	0.37	1.27	0.19	0.81	0.06	0.55	0.02	0.37	0.01				
10	8.42	17.66	4.93	4.79	2.99	1.42	1.86	0.45	1.41	0.23	0.90	0.08	0.61	0.03	0.41	0.01				
12	10.11	24.75	5.91	6.71	3.58	1.98	2.23	0.63	1.69	0.32	1.08	0.11	0.73	0.04	0.49	0.02				
14	11.79	32.93	6.90	8.93	4.18	2.64	2.60	0.83	1.98	0.43	1.26	0.14	0.86	0.06	0.58	0.02				
16	13.48	42.16	7.88	11.44	4.78	3.38	2.97	1.07	2.26	0.55	1.44	0.18	0.98	0.07	0.66	0.03	0.40	0.01		
18	15.16	52.44	8.87	14.23	5.37	4.21	3.34	1.33	2.54	0.68	1.62	0.23	1.10	0.09	0.74	0.03	0.45	0.01		
20			9.85	17.29	5.97	5.11	3.72	1.61	2.82	0.83	1.80	0.28	1.22	0.11	0.82	0.04	0.50	0.01		
22			10.84	20.63	6.57	6.10	4.09	1.92	3.11	0.99	1.98	0.33	1.35	0.13	0.91	0.05	0.55	0.01		
24			11.82	24.24	7.17	7.17	4.46	2.26	3.39	1.16	2.16	0.39	1.47	0.15	0.99	0.06	0.60	0.02		
26			12.81	28.11	7.76	8.31	4.83	2.62	3.67	1.34	2.34	0.45	1.59	0.18	1.07	0.07	0.65	0.02		
28			13.80	32.25	8.36	9.53	5.20	3.01	3.95	1.54	2.52	0.52	1.71	0.20	1.15	0.08	0.70	0.02		
30			14.78	36.64	8.96	10.83	5.57	3.41	4.24	1.75	2.70	0.59	1.84	0.23	1.24	0.09	0.75	0.03		
32					9.55	12.21	5.94	3.85	4.52	1.97	2.88	0.66	1.96	0.26	1.32	0.10	0.80	0.03	0.37	0.00
34					10.15	13.66	6.32	4.31	4.80	2.21	3.06	0.74	2.08	0.29	1.40	0.11	0.85	0.03	0.39	0.00
36					10.75	15.18	6.69	4.79	5.08	2.45	3.24	0.82	2.20	0.32	1.48	0.12	0.90	0.04	0.41	0.01
38					11.35	16.78	7.06	5.29	5.36	2.71	3.42	0.91	2.33	0.36	1.57	0.14	0.95	0.04	0.44	0.01
40					11.94	18.45	7.43	5.82	5.65	2.98	3.60	1.00	2.45	0.39	1.65	0.15	1.00	0.04	0.46	0.01
42					12.54	20.20	7.80	6.37	5.93	3.27	3.78	1.09	2.57	0.43	1.73	0.16	1.05	0.05	0.48	0.01
44					13.14	22.02	8.17	6.94	6.21	3.56	3.96	1.19	2.69	0.47	1.81	0.18	1.10	0.05	0.51	0.01
46					13.73	23.91	8.55	7.54	6.49	3.86	4.14	1.29	2.82	0.51	1.90	0.19	1.15	0.06	0.53	0.01
48					14.33	25.87	8.92	8.15	6.78	4.18	4.32	1.40	2.94	0.55	1.98	0.21	1.20	0.06	0.55	0.01
50					14.93	27.90	9.29	8.79	7.06	4.51	4.50	1.51	3.06	0.59	2.06	0.23	1.25	0.07	0.58	0.01
55							10.22	10.49	7.76	5.38	4.95	1.80	3.37	0.71	2.27	0.27	1.37	0.08	0.63	0.01
60							11.15	12.33	8.47	6.32	5.40	2.11	3.67	0.83	2.47	0.32	1.50	0.09	0.69	0.01
65							12.07	14.30	9.18	7.33	5.85	2.45	3.98	0.96	2.68	0.37	1.62	0.11	0.75	0.02
70							13.00	16.40	9.88	8.41	6.30	2.81	4.29	1.10	2.89	0.42	1.74	0.12	0.81	0.02
75							13.93	18.63	10.59	9.56	6.75	3.20	4.59	1.25	3.09	0.48	1.87	0.14	0.86	0.02
80							14.86	21.00	11.29	10.77	7.20	3.60	4.90	1.41	3.30	0.54	1.99	0.16	0.92	0.02
85									12.00	12.05	7.65	4.03	5.21	1.58	3.50	0.60	2.12	0.18	0.98	0.03
90									12.71	13.40	8.10	4.48	5.51	1.76	3.71	0.67	2.24	0.20	1.04	0.03
95									13.41	14.81	8.55	4.95	5.82	1.94	3.92	0.74	2.37	0.22	1.09	0.03
100									14.12	16.28	9.00	5.45	6.12	2.13	4.12	0.81	2.49	0.24	1.15	0.04
110											9.90	6.50	6.74	2.55	4.53	0.97	2.74	0.29	1.27	0.04
120											10.80	7.63	7.35	2.99	4.95	1.14	2.99	0.34	1.38	0.05
130											11.70	8.85	7.96	3.47	5.36	1.32	3.24	0.39	1.50	0.06
140											12.60	10.16	8.57	3.98	5.77	1.52	3.49	0.45	1.61	0.07
150											13.50	11.54	9.19	4.52	6.18	1.73	3.74	0.51	1.73	0.08
160											14.40	13.01	9.80	5.10	6.60	1.95	3.99	0.57	1.84	0.09
170													10.41	5.70	7.01	2.18	4.24	0.64	1.96	0.10
180													11.02	6.34	7.42	2.42	4.49	0.71	2.07	0.11
190													11.64	7.01	7.83	2.67	4.74	0.79	2.19	0.12
200													12.25	7.71	8.24	2.94	4.98	0.86	2.30	0.13
220													13.47	9.19	9.07	3.51	5.48	1.03	2.53	0.16
240													14.70	10.80	9.89	4.12	5.98	1.21	2.76	0.18
260															10.72	4.78	6.48	1.41	2.99	0.21
280															11.54	5.48	6.98	1.61	3.22	0.25
300															12.37	6.23	7.48	1.83	3.45	0.28
320															13.19	7.02	7.98	2.06	3.68	0.31
340															14.02	7.86	8.47	2.31	3.91	0.35
360															14.84	8.73	8.97	2.57	4.14	0.39
380																	9.47	2.84	4.37	0.43
400																	9.97	3.12	4.60	0.48
420																	10.47	3.42	4.83	0.52
440																	10.97	3.72	5.06	0.57
460																	11.46	4.04	5.29	0.62
480																	11.96	4.37	5.52	0.67
500																	12.46	4.72	5.75	0.72

Shaded areas represent velocities over 5 fps.
Use with caution where water hammer is a concern.

FRICION LOSS CHARTS

Irrigation Association Friction Loss Chart 2008
SCHEDULE 40 PVC IPS PLASTIC PIPE
 ASTM D-1785 (1120,1220) C=150 • PSI Loss Per 100 Feet of Pipe

Nominal Size	1/2"		3/4"		1"		1 1/4"		1 1/2"		2"		2 1/2"		3"		4"		6"	
	Avg. ID	0.602	0.804	1.050	1.315	1.660	1.900	2.375	2.750	3.042	4.500	6.031	8.031	9.031	10.763	14.375	18.750	24.000	30.000	36.000
Flow GPM	Velocity	PSI	Velocity	PSI	Velocity	PSI	Velocity	PSI	Velocity	PSI	Velocity	PSI	Velocity	PSI	Velocity	PSI	Velocity	PSI	Velocity	PSI
Min Wall	FPS	LOSS	FPS	LOSS	FPS	LOSS	FPS	LOSS	FPS	LOSS	FPS	LOSS	FPS	LOSS	FPS	LOSS	FPS	LOSS	FPS	LOSS
1	1.13	0.50	0.63	0.12	0.39	0.04	0.22	0.01	0.16	0.00										
2	2.25	1.82	1.26	0.44	0.77	0.13	0.44	0.03	0.32	0.02	0.19	0.00								
3	3.38	3.85	1.89	0.94	1.16	0.28	0.66	0.07	0.48	0.03	0.29	0.01								
4	4.50	6.55	2.52	1.60	1.54	0.48	0.88	0.12	0.65	0.06	0.39	0.02	0.27	0.01						
5	5.63	9.91	3.16	2.42	1.93	0.73	1.10	0.19	0.81	0.09	0.49	0.03	0.34	0.01						
6	6.75	13.89	3.79	3.40	2.31	1.02	1.32	0.26	0.97	0.12	0.58	0.04	0.41	0.02	0.26	0.01				
7	7.88	18.48	4.42	4.52	2.70	1.36	1.54	0.35	1.13	0.16	0.68	0.05	0.48	0.02	0.31	0.01				
8	9.01	23.66	5.05	5.79	3.08	1.74	1.76	0.45	1.29	0.21	0.78	0.06	0.55	0.03	0.35	0.01				
9	10.13	29.43	5.68	7.20	3.47	2.17	1.99	0.56	1.45	0.26	0.88	0.08	0.61	0.03	0.40	0.01				
10	11.26	35.77	6.31	8.75	3.85	2.63	2.21	0.68	1.61	0.32	0.97	0.09	0.68	0.04	0.44	0.01				
12	13.51	50.14	7.57	12.27	4.62	3.69	2.65	0.95	1.94	0.44	1.17	0.13	0.82	0.05	0.53	0.02				
14	15.76	66.71	8.84	16.32	5.39	4.91	3.09	1.26	2.26	0.59	1.36	0.17	0.96	0.07	0.62	0.03				
16	18.01	85.42	10.10	20.90	6.17	6.29	3.53	1.62	2.58	0.76	1.56	0.22	1.09	0.09	0.71	0.03	0.41	0.01		
18	20.26	106.24	11.36	25.99	6.94	7.82	3.97	2.01	2.90	0.94	1.75	0.28	1.23	0.12	0.79	0.04	0.46	0.01		
20			12.62	31.59	7.71	9.51	4.41	2.45	3.23	1.14	1.95	0.33	1.36	0.14	0.88	0.05	0.51	0.01		
22			13.89	37.69	8.48	11.35	4.85	2.92	3.55	1.37	2.14	0.40	1.50	0.17	0.97	0.06	0.56	0.02		
24			15.15	44.28	9.25	13.33	5.29	3.43	3.87	1.60	2.34	0.47	1.64	0.20	1.06	0.07	0.61	0.02		
26			16.41	51.36	10.02	15.46	5.74	3.98	4.20	1.86	2.53	0.54	1.77	0.23	1.15	0.08	0.66	0.02		
28			17.67	58.91	10.79	17.73	6.18	4.56	4.52	2.13	2.73	0.62	1.91	0.26	1.23	0.09	0.71	0.02		
30			18.94	66.94	11.56	20.15	6.62	5.19	4.84	2.42	2.92	0.71	2.05	0.30	1.32	0.10	0.77	0.03		
32					12.33	22.71	7.06	5.85	5.16	2.73	3.12	0.80	2.18	0.34	1.41	0.12	0.82	0.03	0.36	0.00
34					13.10	25.41	7.50	6.54	5.49	3.06	3.31	0.89	2.32	0.38	1.50	0.13	0.87	0.03	0.38	0.00
36					13.87	28.24	7.94	7.27	5.81	3.40	3.51	0.99	2.46	0.42	1.59	0.14	0.92	0.04	0.40	0.01
38					14.64	31.22	8.38	8.04	6.13	3.76	3.70	1.10	2.59	0.46	1.68	0.16	0.97	0.04	0.43	0.01
40					15.41	34.33	8.82	8.84	6.46	4.13	3.89	1.21	2.73	0.51	1.76	0.18	1.02	0.05	0.45	0.01
42					16.18	37.58	9.26	9.67	6.78	4.52	4.09	1.32	2.87	0.56	1.85	0.19	1.07	0.05	0.47	0.01
44					16.95	40.96	9.71	10.54	7.10	4.93	4.28	1.44	3.00	0.61	1.94	0.21	1.12	0.06	0.49	0.01
46					17.73	44.47	10.15	11.45	7.42	5.35	4.48	1.57	3.14	0.66	2.03	0.23	1.17	0.06	0.52	0.01
48					18.50	48.12	10.59	12.39	7.75	5.79	4.67	1.69	3.28	0.71	2.12	0.25	1.23	0.07	0.54	0.01
50					19.27	51.90	11.03	13.36	8.07	6.25	4.87	1.83	3.41	0.77	2.20	0.27	1.28	0.07	0.56	0.01
55							12.13	15.94	8.88	7.45	5.36	2.18	3.75	0.92	2.42	0.32	1.40	0.08	0.62	0.01
60							13.24	18.72	9.68	8.75	5.84	2.56	4.09	1.08	2.65	0.37	1.53	0.10	0.67	0.01
65							14.34	21.72	10.49	10.15	6.33	2.97	4.44	1.25	2.87	0.43	1.66	0.11	0.73	0.02
70							15.44	24.91	11.30	11.65	6.82	3.41	4.78	1.43	3.09	0.50	1.79	0.13	0.79	0.02
75							16.54	28.31	12.10	13.23	7.30	3.87	5.12	1.63	3.31	0.56	1.91	0.15	0.84	0.02
80							17.65	31.90	12.91	14.91	7.79	4.36	5.46	1.84	3.53	0.63	2.04	0.17	0.90	0.02
85									13.72	16.69	8.28	4.88	5.80	2.06	3.75	0.71	2.17	0.19	0.95	0.03
90									14.52	18.55	8.76	5.43	6.14	2.29	3.97	0.79	2.30	0.21	1.01	0.03
95									15.33	20.50	9.25	6.00	6.48	2.53	4.19	0.87	2.42	0.23	1.07	0.03
100									16.14	22.55	9.74	6.59	6.82	2.78	4.41	0.96	2.55	0.25	1.12	0.03
110									10.71	7.87	7.51	3.31	4.85	1.14	2.81	0.30	1.23	0.04		
120									11.68	9.24	8.19	3.89	5.29	1.34	3.06	0.36	1.35	0.05		
130									12.66	10.72	8.87	4.52	5.73	1.56	3.32	0.41	1.46	0.06		
140									13.63	12.30	9.55	5.18	6.17	1.79	3.57	0.47	1.57	0.06		
150									14.61	13.97	10.24	5.89	6.61	2.03	3.83	0.54	1.68	0.07		
160									15.58	15.75	10.92	6.63	7.05	2.29	4.08	0.61	1.79	0.08		
170											11.60	7.42	7.50	2.56	4.34	0.68	1.91	0.09		
180											12.28	8.25	7.94	2.85	4.59	0.75	2.02	0.10		
190											12.97	9.12	8.38	3.15	4.85	0.83	2.13	0.11		
200											13.65	10.03	8.82	3.46	5.11	0.92	2.24	0.12		
220											15.01	11.96	9.70	4.13	5.62	1.09	2.47	0.15		
240											16.38	14.06	10.58	4.85	6.13	1.28	2.69	0.17		
260													11.46	5.63	6.64	1.49	2.92	0.20		
280													12.35	6.46	7.15	1.71	3.14	0.23		
300													13.23	7.34	7.66	1.94	3.37	0.26		
320													14.11	8.27	8.17	2.19	3.59	0.30		
340													14.99	9.25	8.68	2.45	3.81	0.33		
360													15.87	10.29	9.19	2.72	4.04	0.37		
380															9.70	3.01	4.26	0.41		
400															10.21	3.31	4.49	0.45		
420															10.72	3.62	4.71	0.49		
440															11.23	3.95	4.94	0.53		
460															11.74	4.28	5.16	0.58		
480															12.25	4.64	5.38	0.63		
500															12.76	5.00	5.61	0.68		

Shaded areas represent velocities over 5 fps.
 Use with caution where water hammer is a concern.

TECHNICAL

Irrigation Association Friction Loss Chart 2008
POLYETHYLENE PLASTIC PIPE ID CONTROLLED
 PE 3408 ASTM D 2239 C=140 • PSI LOSS PER 100 FEET OF PIPE

Nominal Size Avg. ID	1/2" 0.622		3/4" 0.824		1" 1.049		1-1/4" 1.380		1-1/2" 1.610		2" 2.067		2-1/2" 2.469		3" 3.068		4" 4.026	
	Velocity FPS	PSI LOSS	Velocity FPS	PSI LOSS	Velocity FPS	PSI LOSS	Velocity FPS	PSI LOSS	Velocity FPS	PSI LOSS	Velocity FPS	PSI LOSS	Velocity FPS	PSI LOSS	Velocity FPS	PSI LOSS	Velocity FPS	PSI LOSS
1	1.05	0.49	0.60	0.12	0.37	0.04	0.21	0.01	0.16	0.00								
2	2.11	1.76	1.20	0.45	0.74	0.14	0.43	0.04	0.31	0.02	0.19	0.01						
3	3.16	3.73	1.80	0.95	1.11	0.29	0.64	0.08	0.47	0.04	0.29	0.01						
4	4.22	6.35	2.40	1.62	1.48	0.50	0.86	0.13	0.63	0.06	0.38	0.02	0.27	0.01				
5	5.27	9.60	3.00	2.44	1.85	0.76	1.07	0.20	0.79	0.09	0.48	0.03	0.33	0.01				
6	6.33	13.46	3.61	3.43	2.22	1.06	1.29	0.28	0.94	0.13	0.57	0.04	0.40	0.02	0.26	0.01		
7	7.38	17.91	4.21	4.56	2.60	1.41	1.50	0.37	1.10	0.18	0.67	0.05	0.47	0.02	0.30	0.01		
8	8.44	22.93	4.81	5.84	2.97	1.80	1.71	0.47	1.26	0.22	0.76	0.07	0.54	0.03	0.35	0.01		
9	9.49	28.52	5.41	7.26	3.34	2.24	1.93	0.59	1.42	0.28	0.86	0.08	0.60	0.03	0.39	0.01		
10	10.55	34.67	6.01	8.82	3.71	2.73	2.14	0.72	1.57	0.34	0.95	0.10	0.67	0.04	0.43	0.01		
12			7.21	12.37	4.45	3.82	2.57	1.01	1.89	0.48	1.15	0.14	0.80	0.06	0.52	0.02		
14			8.41	16.45	5.19	5.08	3.00	1.34	2.20	0.63	1.34	0.19	0.94	0.08	0.61	0.03		
16			9.61	21.07	5.93	6.51	3.43	1.71	2.52	0.81	1.53	0.24	1.07	0.10	0.69	0.04	0.40	0.01
18			10.82	26.21	6.67	8.10	3.86	2.13	2.83	1.01	1.72	0.30	1.20	0.13	0.78	0.04	0.45	0.01
20			12.02	31.85	7.42	9.84	4.28	2.59	3.15	1.22	1.91	0.36	1.34	0.15	0.87	0.05	0.50	0.01
22					8.16	11.74	4.71	3.09	3.46	1.46	2.10	0.43	1.47	0.18	0.95	0.06	0.55	0.02
24					8.90	13.79	5.14	3.63	3.78	1.72	2.29	0.51	1.61	0.21	1.04	0.07	0.60	0.02
26					9.64	16.00	5.57	4.21	4.09	1.99	2.48	0.59	1.74	0.25	1.13	0.09	0.65	0.02
28					10.38	18.35	6.00	4.83	4.41	2.28	2.67	0.68	1.87	0.28	1.21	0.10	0.70	0.03
30					11.12	20.85	6.43	5.49	4.72	2.59	2.86	0.77	2.01	0.32	1.30	0.11	0.76	0.03
32					11.86	23.50	6.86	6.19	5.04	2.92	3.06	0.87	2.14	0.36	1.39	0.13	0.81	0.03
34					12.61	26.29	7.28	6.92	5.35	3.27	3.25	0.97	2.28	0.41	1.47	0.14	0.86	0.04
36							7.71	7.69	5.67	3.63	3.44	1.08	2.41	0.45	1.56	0.16	0.91	0.04
38							8.14	8.50	5.98	4.02	3.63	1.19	2.54	0.50	1.65	0.17	0.96	0.05
40							8.57	9.35	6.30	4.42	3.82	1.31	2.68	0.55	1.73	0.19	1.01	0.05
42							9.00	10.24	6.61	4.83	4.01	1.43	2.81	0.60	1.82	0.21	1.06	0.06
44							9.43	11.16	6.93	5.27	4.20	1.56	2.94	0.66	1.91	0.23	1.11	0.06
46							9.86	12.12	7.24	5.72	4.39	1.70	3.08	0.71	1.99	0.25	1.16	0.07
48							10.28	13.11	7.56	6.19	4.58	1.84	3.21	0.77	2.08	0.27	1.21	0.07
50							10.71	14.14	7.87	6.68	4.77	1.98	3.35	0.83	2.17	0.29	1.26	0.08
55							11.78	16.87	8.66	7.97	5.25	2.36	3.68	0.99	2.38	0.35	1.38	0.09
60							12.85	19.82	9.44	9.36	5.73	2.77	4.02	1.17	2.60	0.41	1.51	0.11
65									10.23	10.86	6.21	3.22	4.35	1.36	2.82	0.47	1.64	0.13
70									11.02	12.45	6.68	3.69	4.69	1.55	3.03	0.54	1.76	0.14
75									11.81	14.15	7.16	4.19	5.02	1.77	3.25	0.61	1.89	0.16
80									12.59	15.95	7.64	4.73	5.35	1.99	3.47	0.69	2.01	0.18
85									13.38	17.84	8.12	5.29	5.69	2.23	3.68	0.77	2.14	0.21
90											8.59	5.88	6.02	2.48	3.90	0.86	2.27	0.23
95											9.07	6.50	6.36	2.74	4.12	0.95	2.39	0.25
100											9.55	7.15	6.69	3.01	4.33	1.05	2.52	0.28
110											10.50	8.53	7.36	3.59	4.77	1.25	2.77	0.33
120											11.46	10.02	8.03	4.22	5.20	1.47	3.02	0.39
130											12.41	11.62	8.70	4.89	5.63	1.70	3.27	0.45
140											13.37	13.33	9.37	5.61	6.07	1.95	3.52	0.52
150													10.04	6.38	6.50	2.22	3.78	0.59
160													10.71	7.19	6.94	2.50	4.03	0.67
170													11.38	8.04	7.37	2.79	4.28	0.74
180													12.05	8.94	7.80	3.11	4.53	0.83
190													12.72	9.88	8.24	3.43	4.78	0.92
200													13.39	10.87	8.67	3.78	5.03	1.01
220															9.54	4.50	5.54	1.20
240															10.40	5.29	6.04	1.41
260															11.27	6.14	6.54	1.64
280															12.14	7.04	7.05	1.88
300															13.00	8.00	7.55	2.13
320															13.87	9.02	8.05	2.40
340																	8.56	2.69
360																	9.06	2.99
380																	9.57	3.30
400																	10.07	3.63
420																	10.57	3.98
440																	11.08	4.33
460																	11.58	4.71
480																	12.08	5.09
500																	12.59	5.49

Shaded areas represent velocities over 5 fps.
Use with caution where water hammer is a concern.

TECHNICAL

FRICION LOSS CHARTS

TABLE OF APPROXIMATE PRESSURE LOSSES FOR PIPE FITTINGS

Listed in Equivalent Feet of Pipe

Steel Fitting Type	1/2"	3/4"	1"	1-1/4"	1-1/2"	2"	2-1/2"	3"	4"	6"	8"
Coupling	0.6	0.8	1.0	1.2	1.5	2.0	2.5	3.0	4.0	6.0	8.0
Run of St. Tee	1.0	1.0	1.5	2.0	2.0	2.5	3.0	4.0	5.0	7.0	10.0
Tee, Side Outlet	3.0	4.5	5.0	7.0	9.0	11.0	13.0	16.0	20.0	31.0	42.0
Tee, Run Reduced 1/2"	1.5	2.5	3.0	4.0	5.0	6.0	7.0	8.0	12.0	16.0	20.0
Elbow, 90°	1.5	2.5	3.0	4.0	5.0	6.0	7.0	8.0	12.0	16.0	20.0
Elbow, 45°	0.75	1.0	1.3	1.7	2.0	2.5	3.0	3.5	5.0	7.5	10.0
Corporation Stop	9.0	9.0	9.0	9.0	9.0	9.0					
Curb Stop	6.0	6.0	7.0	7.0	8.0	8.0					
Plastic IPS or Copper Fitting Type	1/2"	3/4"	1"	1-1/4"	1-1/2"	2"	2-1/2"	3"	4"	6"	8"
Coupling	1.5	2.5	3.0	3.0	4.0	6.0	7.0	8.0	11.0	18.0	24.0
Run of St. Tee	2.5	3.0	4.0	5.0	6.0	8.0	9.0	11.0	15.0	21.0	28.0
Tee, Side Outlet	7.0	9.0	12.0	15.0	18.0	24.0	30.0	36.0	45.0	70.0	90.0
Tee, Run Reduced 1/2"	3.5	4.5	6.0	8.0	9.0	11.0	14.0	17.0	24.0	34.0	45.0
Elbow, 90°	3.5	4.5	6.0	8.0	9.0	11.0	14.0	17.0	24.0	34.0	45.0
Elbow, 34°	1.5	2.0	3.0	3.5	4.0	5.0	7.0	8.0	10.0	16.0	20.0

To use this chart, multiply the approximate "equivalent feet of pipe" value by the proper pipe pressure loss per 100 feet rating, then divide by 100. The result is the fitting loss in PSI.

Note: It is recommended that the above chart be used only when the manufacturers recommended pressure loss values are not available.

TECHNICAL

WIRE DATA

Standard Annealed Copper at 20° C

American Wire Gauge	Metric Wire Gauge	Diameter Mils	Diameter mm	Resistance Per mft Ohms	Resistance Per km Ohms
1		289.3	7.348	0.9239	0.4065
	7.0		7.000		0.4480
2		257.6	6.543	0.1563	0.5128
	6.0		6.000		0.6098
3		229.4	5.827	0.1971	0.6466
4		204.3	5.189	0.2485	0.8152
	5.0		5.000		0.08781
5		181.9	4.620	0.3134	1.028
	4.5		4.500		1.084
6		162.0	4.115	0.3952	1.297
	4.0		4.000		1.372
7		144.3	3.665	0.4981	1.634
	3.5		3.500		1.792
8		128.5	3.264	0.6281	2.061
	3.0		3.000		2.439
9		114.4	2.906	0.7925	2.600
10		101.9	2.588	0.9988	3.277
	2.5		2.500		3.512
11		90.7	2.30	1.26	4.14
12		80.8	2.05	1.59	5.21
	2.0		2.00		5.49
13		72.0	1.83	2.00	6.56
	1.8		1.80		6.78
14		64.1	1.63	2.52	8.28
	1.6		1.60		8.58
15		57.1	1.45	3.18	10.4
	1.4		1.40		11.2
16		50.8	1.29	4.02	13.2
	1.2		1.20		15.2
17		45.3	1.15	5.05	16.6
18		40.3	1.02	6.39	21.0
	1.0		1.000		22.0
19		35.9	0.912	8.05	26.4
	0.9		0.900		27.1
20		32.0	0.813	10.1	33.2

WIRE SIZING

Required Information

- Actual one-way length of wire between the controllers and the power source or the controllers and valves
- Allowable voltage loss along the wire circuit
- Accumulative current flowing through the wire section being sized in amperes

Resistance is calculated using this formula:

$$R = \frac{1000 \times AVL}{2L \times I}$$

- R = Maximum Allowable Resistance of wire in ohms per 1000 feet
- AVL = Allowable voltage loss
- L = Wire length (one way)
- I = Inrush current

AVL for controller power wire sizing is calculated by subtracting the minimum operating voltage required by the controller from the minimum available voltage at the power source.

AVL for valve wire sizing is calculated by subtracting minimum solenoid operating voltage from controller output voltage. This number will vary depending on the manufacturer and in some cases with line pressure.

Valve Wire Sizing Example:

Given: The distance from the controller to the valve is 1800 feet. The controller output is 24 V. The valve has a minimum operating voltage of 20 V and an inrush current of 370 mA (0.37 A).

$$R = \frac{1000 \times 4}{2(1800) \times 0.37}$$

$$R = \frac{4000}{1332}$$

$$R = 3.00 \text{ ohms/1000 feet}$$

So, wire resistance can not exceed 3.00 ohms per 1000 feet. Now go to table #1 and select the proper wire size. Since 16 gauge wire has more resistance than 3.00 ohms per 1000 feet, choose 14 gauge wire.

Table 2 is a quick reference and is set up to provide maximum wire runs given the information at the bottom of the table.

Table 1	
Resistance of Copper Wire	
Wire Size AWG No.	Resistance at 20° C (68° F) ohms per 1000 feet
18	6.39
16	4.02
14	2.52
12	1.59
10	1.00
8	0.63
6	0.40
4	0.25

Table 2							
Valve Wire Sizing							
(Maximum One-Way Distance in Feet Between Controller and Valve)							
Ground Wire	Control Wire						
	18	16	14	12	10	8	6
18	850	1040	1210	1350	1460	1540	1590
16	1040	1340	1650	1920	2150	2330	2440
14	1210	1650	2150	2630	3080	3450	3700
12	1350	1920	2630	3390	4170	4880	5400
10	1460	2150	3080	4170	5400	6670	7690
8	1540	2330	3450	4880	6670	8700	10530
6	1590	2440	3700	5400	7690	10530	13330

Heavy-duty solenoid: 24 VAC,
370 mA inrush current, 190 mA holding current, 60 cycles;
475 mA inrush current, 230 mA holding current, 50 cycles

ADDITIONAL DATA

REFERENCE CHART

Approximate Number of Wires to be Installed in Conduit or Tubing

Maximum Number of Wires in Conduit or Sleeveing

Wire Size (AWG)	1/2	3/4	1	1-1/4	1-1/2	2	2-1/2	3	3-1/2	4	5	6	Wire Size (AWG)
18	6	12	20	35	49	80	110	175					18
16	5	10	16	30	42	67	97	150					16
14	4	6	10	18	25	40	56	88	120	150			14
12	3	5	7	15	20	33	50	75	102	130	205		12
10	1	3	6	13	16	27	40	63	85	110	170		10
8	1	2	4	6	9	16	25	35	50	65	105	150	8
6	1	1	3	3	5	10	15	22	32	40	63	92	6
4		1	1	2	4	7	10	16	24	30	48	70	4
2		1	1	2	2	5	9	12	18	22	36	54	2
0			1	1	2	3	5	8	12	15	24	36	0
00			1	1	1	2	4	7	10	14	21	31	00
000				1	1	2	3	6	8	11	18	26	000
0000				1	1	1	2	5	7	10	15	22	0000

ESTIMATING PIPE SIZE

Nominal Pipe Size	Approximate String Length in Inches		
	Copper Pipe	Galvanized (Sch. 40 Steel)	PVC Pipe
1/2"	2"	2-5/8"	2-5/8"
5/8"	2-3/8"		
3/4"	2-3/4"	3-5/16"	3-5/16"
1"	3-1/2"	4-1/8"	4-1/8"
1-1/4"	4-5/16"	5-3/16"	5-3/16"
1-1/2"	5-1/8"	6"	6"
2"	6-3/4"	7-7/16"	7-7/16"

To determine the nominal size of a pipe, wrap a string around the pipe and compare its length to the chart above.

CLIMATE ETp TABLE

Climate*	Inches Daily
Cool Humid	0.10 to 0.15
Cool Dry	0.15 to 0.20
Warm Humid	0.15 to 0.20
Warm Dry	0.20 to 0.25
Hot Humid	0.20 to 0.30
Hot Dry	0.30 to 0.45
	↑ Worst case

* "Cool" equals under 70° F as an average mid-summer high.
 "Warm" equals between 70° and 90° F as mid-summer highs.
 "Hot" equals over 90° F. "Humid" equals over 50% as average mid-summer relative humidity (dry=under 50%).



GET INTO THE SWING, VISIT
WWW.HUNTERGOLF.COM

PLAY ON



Hunter[®]
GOLF



FX
LUMINAIRE

**BRING A LITTLE LIGHT TO YOUR NEXT SITE.
EXPERIENCE FX LUMINAIRE AT WWW.FXL.COM.**

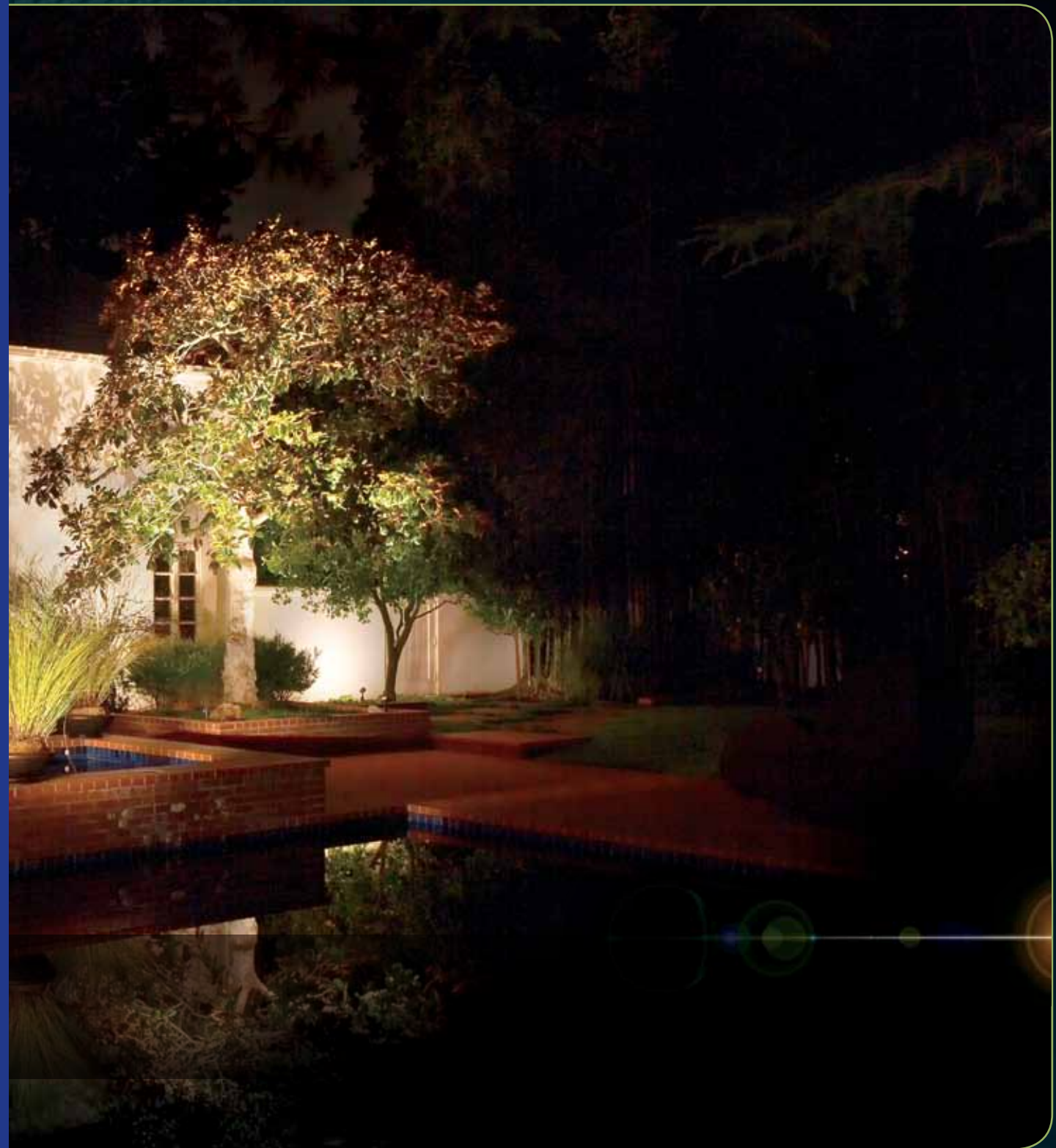

STATEMENT OF WARRANTY

Hunter Industries Incorporated ("Hunter") warrants the following products to be free of defects in materials or workmanship under normal use for a period of two (2) years from the original date of manufacture: PGP-ADJ®, PGJ, MP Rotator family, PS family, PS Ultra family, Spray Nozzles, PCN, PCB, AFB, HPV, PGV family, SRV, SRC, X-Core family, Pro-C family, ROAM, SVC, WVP, WVS, PLD, PACZ, PCZ, AVB, PSR, HCV, SJ, HFT family, SBE family, RZWS, and ET System. Hunter warrants the following products to be free of defects in materials or workmanship under normal use for a period of three (3) years from the original date of manufacture: PGP Ultra family. Hunter warrants the following products to be free of defects in materials or workmanship under normal use for a period of one (1) year from the original date of manufacture: SRM family, Micro Sprays and Stream Drippers. Hunter warrants the following products to be free of defects in materials or workmanship under normal use for a period of five (5) years from the original date of manufacture: I-20, I-25, I-35, I-40, I-60 and I-90 families, Pro-Spray® family, Pro-Spray® PRS30 family, and Pro-Spray® PRS40 family, G-Spray, ICC, I-Core family and ACC controller families, ICD Decoder Products, ICR Remotes, IMMS™ Central Control Products, "Clik" Sensors, Solar-Sync, HQ, ICV plastic, and IBV brass valves, ICZ and PLD tubing. If a defect in a Hunter product is discovered during the applicable warranty period, Hunter will repair or replace, at its option, the product or the defective part. This warranty does not extend to repairs, adjustments, or replacement of a Hunter product or part that results from misuse, negligence, alteration, modification, tampering, or improper installation and/or maintenance of the product. This warranty extends only to the original installer of the Hunter product. If a defect arises in a Hunter product or part during the warranty period, you should contact your local Hunter Authorized Distributor.

HUNTER'S OBLIGATION TO REPAIR OR REPLACE ITS PRODUCTS AS SET FORTH ABOVE IS THE SOLE AND EXCLUSIVE WARRANTY SET FORTH BY HUNTER. THERE ARE NO OTHER WARRANTIES, EXPRESSED OR IMPLIED, INCLUDING WARRANTIES OF MERCHANTABILITY AND FITNESS FOR A PARTICULAR PURPOSE. HUNTER WILL NOT BE LIABLE TO ANY PARTY IN STRICT LIABILITY, TORT, CONTRACT, OR ANY OTHER MANNER FOR DAMAGES CAUSED OR CLAIMED TO BE CAUSED AS A RESULT OF ANY DESIGN OR DEFECT IN HUNTER'S PRODUCTS, OR FOR ANY SPECIAL, INCIDENTAL OR CONSEQUENTIAL DAMAGES OF ANY NATURE.

If you have any questions concerning the warranty or its application, please write to:
Marketing Department, Hunter Industries Incorporated,
1940 Diamond Street, San Marcos, CA 92078, U.S.A.

ASAE CERTIFICATION STATEMENT

Hunter Industries Incorporated certifies that pressure, flow rate, and radius data for these products were determined and listed in accordance with ASAE Standard S398.1, Procedure for Sprinkler Testing and Performance Reporting, and are representative of performance of production sprinklers at the time of publication. Actual product performance may differ from the published specifications due to normal manufacturing variations and sample selection. All other specifications are solely the recommendation of Hunter Industries Incorporated.

Hunter[®]
THE IRRIGATION INNOVATORS

20 11

U.S.A. Headquarters and Manufacturing

1940 Diamond Street
San Marcos, CA 92078
Tel: (1) 760-744-5240
Fax: (1) 760-744-7461
Technical Help: (1) 760-591-7383

Mexico Manufacturing

Calle Nordika #8615
Parque Industrial Nordika
Tijuana, B.C., Mexico C.P. 22709
Tel: (52) 664-903-1300
Fax: (52) 664-903-8078

Worldwide Offices Australia

8 The Parade West
Kent Town, South Australia 5067
Tel: (61) 8-8363-3599
Fax: (61) 8-8363-3687

Europe

Avda. Diagonal 523, 5º- 2º
Edificio Atalaya
08029 Barcelona, Spain
Tel: (34) 9-34-94-88-81
Fax: (34) 9-34-19-76-76

Middle East

P.O. Box 211303
Amman 11121, Jordan
Tel: (962) 6-515-2882
Fax: (962) 6-515-2992

China

B1618, Huibin Office Bldg.
No.8, Beichen Dong Street
Beijing 100101, China
Tel1/Fax: (86) 10-84975146
Tel2: (86) 13-901321516

